



**ski-doo LYNX SEA-DOO. EVINRUDE. ROTAX. Can-am**

**WHAT MATTERS IS  
WHAT'S NEXT**



**RIDING GEAR  
ACCESSORIES  
GENUINE PARTS**

# WELCOME TO WHAT'S NEXT



Welcome to the 2017 Ski-Doo Riding Gear and Accessories Catalog. The biggest news for Ski-Doo in 2017 is the debut of our next 4<sup>th</sup> generation REV platform. There's a lot of amazing stuff about it, but at its heart, it is about you. It's totally designed around the rider so you can get the most out of its technology and have the best snowmobile experience you've ever had.

That's also what we do with our Riding Gear and Accessories. We design our items around you and how you ride so you can have your best time on your sled. That's evident in many of the new items for 2017...

When the 4th generation REV platform based sleds hit the snow, there will be 70 new accessories available. Like all our accessories, they were designed right along with the new platform, so they fit perfectly, look great and are easy to install. And we were sure to cover the most sought-after items, including Auxiliary LED Light, 1 + 1 seat system, skid plates, windshields and more.

We've used your comments to improve items, too. Like a new LinQ Fuel Caddy you can latch a LinQ bag on top of. And the new LinQ bags are more stylish. We redesigned many of our outerwear items to better fit how you ride and new Helium jackets are even more specialized for mountain riding.

We took this designed-around-riders approach in developing this catalog too. We want to make it easy to find the items you're looking for and understand their design and technology. You'll find:



**Riding Gear Performance Ratings:** An industry exclusive, we tell you the level of waterproofness, windproofness, warmth and breathability of our outerwear. This makes it easy to create the right combination of garments to keep you warm.

**Comparison Charts:** See all the items in a category in one chart, with technologies, features, benefits, performance ratings, colors, sizes and prices. It's easy to compare and choose the right one for you.

**Video Links:** Short videos tell the complete story of some of our most full-featured items and bring them to life. You'll find links to them throughout the catalog.

**Tech Zones:** Just like with our sleds, we use the latest technology to get the best performance. These pages will help you understand how they work and how they make your rides better.

And we didn't forget the fun stuff either. You'll find tips from our backcountry experts (and others), product development stories, profiles of inspiring riders and a look inside some race sleds. There's also a more international flavor as Ski-Doo grows around the world.

We are always looking for the next way to make your snowmobile experience great. You'll find that on nearly every one of the next 176 pages.

Enjoy this catalog and think snow!

**Your Riding Gear, Accessories and Genuine Parts Team**

## PARTS & ACCESSORIES

92 Platform/Accessories fit guide

### CUSTOMIZED SLEDS

- 97 Summit SP 850 E-TEC
- 98 MXZ X 850 E-TEC
- 99 Renegade Backcountry
- 100 Renegade Adrenaline

### ACCESSORIES

- 102 LinQ™ System
- 107 Windshields/Wind Protection
- 113 Mirrors
- 114 Handlebar Air Deflectors & Handlebars
- 115 LED Lights

116 Adjustable Risers & Extension Kits

- 118 Protection/Reinforcement
- 125 Toe-Holds/Reinforcement
- 126 Winch & Accessories
- 127 Vent & Grille Kits
- 128 Exclusive Sled Wrap Kits
- 129 Seats, Backrests/Footrests
- 132 Storage/Cargo
- 142 Traction & Control
- 154 Parts & Performance
- 161 Electronics/Electrical
- 164 Installation Parts
- 165 Garage/Stickers
- 166 Trailering/Covers
- 168 XPS

## SPECIAL FEATURES

2 Ski-Doo Store

3 Riding Gear, Parts & Accessories Warranty

4 Summit REV (G4) Accessories & Riding Gear Proposal

6 MXZ REV (G4) Accessories & Riding Gear Proposal

8 BRP Performance Rating System

22 Good habits for avalanche terrain

23 Multi day ride on trails

26 The Crossover boom

33 Ski-Doo backcountry expert profile

43 Cornerstone of riding experience

54 Know your helmet safety ratings

54 What backcountry experts wear under the lid

81 Growing passion for freeriding to the XX power

96 At the peak of performance

101 Quick swap your windshield for comfort

104 Ski-Doo LinQ System

105 Two sleds in one: Renegade with accessories

106 Build your dream sled

123 Freedom for your feet

142 Traction made easier

148 Tech focus - Skis & Carbides

153 Why you should use Genuine BRP Parts

159 Tech focus - Drive belts

160 BRP engine rebuilt center

170 Choosing the best for the harshest conditions

173 Maintenance tips to help keep your Ski-Doo snowmobile like new

174 Using the right oil matters

175 Maintenance chart

## 2017 RIDING GEAR, ACCESSORIES & GENUINE PARTS

### RIDING GEAR

- 14 Mountain
- 27 Crossover
- 28 Trail Performance
- 34 Touring
- 44 Recreational / Utility
- 45 Technical Wear
- 50 Helmets
- 61 Balaclavas
- 62 Goggles
- 64 Gloves & Mitts
- 69 Headwear
- 70 Boots & Socks

- 72 Bags & TEK Vest
- 74 Sportswear
- 85 Sizing Chart
- 86 Teenwear
- 88 Kidswear

### TECH ZONE

- 10 Technology guide
- 12 Sympatex
- 13 PrimaLoft & RPM
- 45 Technical Wear
- 54 Modular 3 Helmet
- 55 BV2S Helmet



### GET THE RIGHT GEAR

Wearing gear for the type of riding you do will maximize your snowmobiling experience. Look for the icon that best matches your riding style:



MOUNTAIN



CROSSOVER



TRAIL PERFORMANCE



TOURING



RECREATIONAL / UTILITY

### LEARN MORE AT A GLANCE

Look for these icons throughout the catalog to learn a bit more about key products.

**NEW** New item for 2017.

**DID YOU KNOW** An interesting tidbit about an item beyond the product description.

**INNOVATION** An item BRP pioneered that takes your ride to the next level.

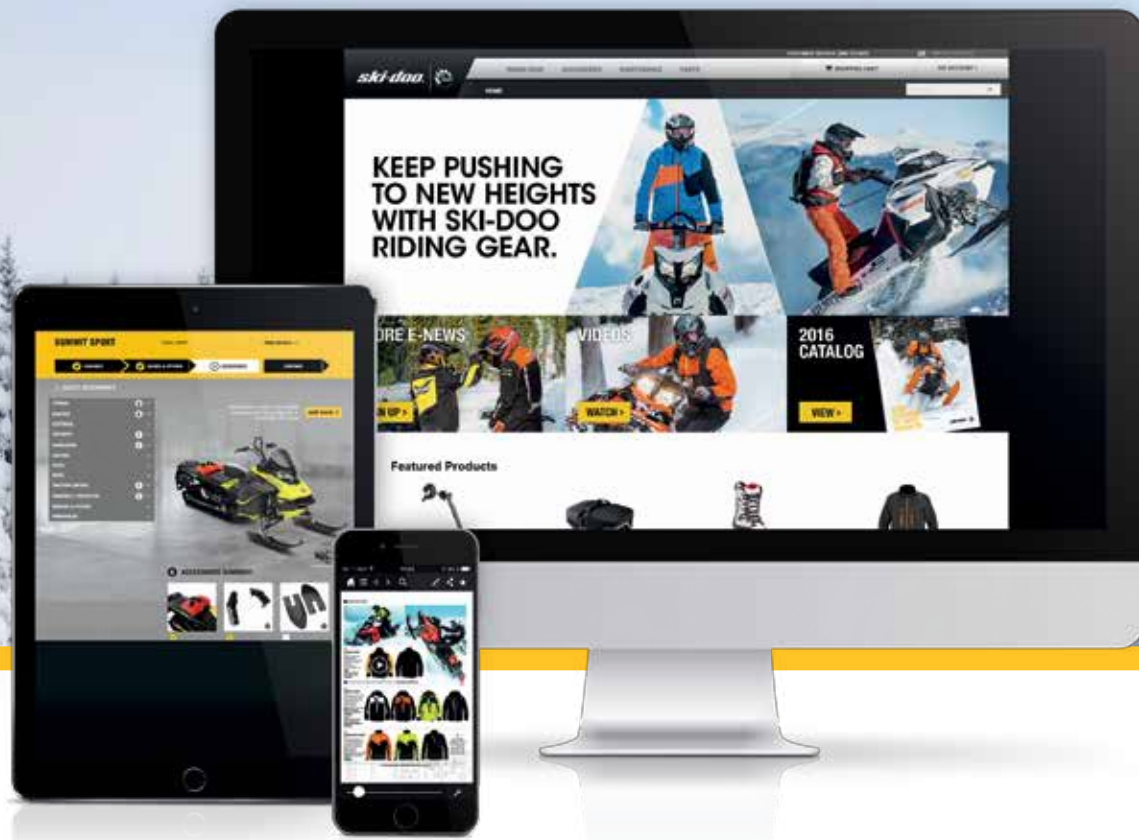

**WWW.STORE.SKI-DOO.COM**



Shop online store for parts, accessories and riding gear.



Sign up for Ski-Doo eNews and get free shipping the next time you buy online.  
\*Valid with order of \$150 and more.



Get your oils and lubricants online.



Explore all our products in the interactive online catalog. Jump directly to products with the interactive table of contents, watch videos, large format images and share your favorite items via social media.



Download the free BRP magazine app on the App Store or Google Play to access all BRP's catalogs. Browse through the publication and enjoy add-ons like social media and annotation features, bookmarking and video streaming.



Instantly view your dream Ski-Doo snowmobile as you build it.  
[www.ski-doo.com/build-and-price](http://www.ski-doo.com/build-and-price)



Check out our videos to learn more about our new and innovative Riding Gear & Accessories.  
[www.ski-doo.com/genuine-parts-accessories-riding-gear/catalog-video](http://www.ski-doo.com/genuine-parts-accessories-riding-gear/catalog-video)



Access the sled wrap online store.  
[www.scsskidowraps.com](http://www.scsskidowraps.com)



The 2017 Ski-Doo lineup will be available at your authorized Ski-Doo dealer and online to purchase in September 2016.

IF WE SELL IT,  
WE STAND BY IT.

**BRP  
LIMITED  
WARRANTY\***

FOR NEW PARTS,  
ACCESSORIES  
AND RIDING GEAR



**GENUINE BRP PARTS AND ACCESSORIES**  
installed by you or your authorized BRP dealer

**1 YEAR LIMITED WARRANTY\*\***

**AFTERMARKET PRODUCTS SOLD FROM BRP**

**1 YEAR LIMITED WARRANTY\*\***



**RIDING GEAR**  
except SympaTex gear

**1 YEAR LIMITED WARRANTY\*\***

**SYMPATEX RIDING GEAR**

**LIFETIME† WARRANTY\*\***



**HELMETS**

**4 YEAR LIMITED WARRANTY\*\***



**GET ALL THE DETAILS FROM YOUR SKI-DOO DEALER**

For advertising purposes, some scenes depicted in this brochure include professional riders and racers executing maneuvers or performances under ideal and/or controlled conditions. Do not attempt any of these or any other risky maneuvers if they're beyond your level of riding ability, as well as your understanding and respect for the performance of your snowmobile. Always ride responsibly and safely. Always observe applicable local laws and regulations. Always wear the appropriate protective clothing, including a helmet. And remember, if you're going to drink, please don't ride. Because of its ongoing commitment to product quality and innovation, Bombardier Recreational Products Inc. (BRP) reserves the right, at any time, to discontinue or change specifications, prices, designs, features, models or equipment without incurring any obligation. Some models depicted herein may include optional equipment. Prices are based on Manufacturer Suggested Retail Prices. Dealer may sell for a different price. Taxes are not included. BRP is a proud member of SSSC (Snowmobiling Safety Certification Committee), Machine Safety Standard, Operator Safety Training, Safe Trails, ISMA (International Snowmobile Manufacturers Association), National Snowmobile Foundation and Tread Lightly! Inc. By being a member of these important snowmobiling associations, we recognize and support their efforts in promoting the growth of our sport. Hipora is a registered trademark of Kolon Industries, Inc. Isolfil is a registered trademark for Yarns and Threads For Textile. mcFIT and mcTEX are registered trademarks of MCTECH Corporation. Microban is a registered trademark of Microban International. PrimaLoft Gold, PrimaLoft Silver and PrimaLoft Black are registered trademarks of Albany International Corp. Sympatex is a registered trademark of Sympatex Technologies GmbH. Dri-Release is a registered trademark of Optimer brands. Kevlar is a trademark of E.I. DuPont de Nemours & Co. Thermolite, Lycra, CORDURA and COOLMAX are registered trademarks of INVISTA for durable fabrics. ThermoCool is a registered trademark of ADVANSA. Thinsulate is a registered trademark of 3M Corporation. Velcro is a registered trademark of Velcro Industries. X-STATIC is a registered trademark of Noble Biomaterials Europe srl. NO-FOG is a trademark of NO-FOG USA. Scott is a trademark of Scott Sports SA. OutDry is a registered trademark of OutDry Technologies Corporation. GTX is a trademark of Castrol Limited used under license. KYB is a registered trademark of Kayaba. Montana and Zumo are registered trademarks of Garmin Ltd. NGK is a registered trademark of NGK Spark Plugs, Ltd. Extender Trail III, Trail Blazer IV, Executive, Flat-top and Dooly are trademarks and registered trademarks of Woody's International Engineering and Manufacturing, Inc. RipSaw, RipSaw Lite, ICE Ripper, ICE Ripper XT, ICE Attak and Powder Max are trademarks of Camoplast Inc. Lexan is a registered trademark of SABIC Innovative Plastics. Silicone is a trademark of Dow Corning Corporation. Superclamp II is a trademark of Bowdriks Industries. SuperFabric is a registered trademark of Higher Dimension Materials, Inc (HDM). Ax Suede is a registered trademark of MatMarket, Inc. FOX is a registered trademark of Fox Racing Canada. KOLPIN, GUN BOOT and IMPACT are registered trademarks of Kolpin Powersports Inc. YUASA is a registered trademark of YUASA Batteries Inc. Cyclops is a registered trademark of CyclopsGear. Waterguard is a registered trademark of Kombi Ltd. Makita is a registered trademark of Makita. Depending on location, products are distributed by BRP US Inc., Bombardier Recreational Products Inc., BRP European Distribution SA, BRP Finland Oy., BRP Australia Pty Ltd. or Bombardier Recreational, Products Motores da Amazonia Ltda. In the U.S.A., products are distributed by BRP US Inc. In Canada, products are distributed by Bombardier Recreational Products Inc. ® are registered trademarks and ™ and the BRP logo trademarks of Bombardier Recreational Products Inc. or its affiliates. All other company and/or product names are trademarks or registered trademarks of their respective holders. © 2016 BRP. All rights reserved. Printed in Canada.

† Use other than which the product is designed for will void the product lifetime warranty.

\* Purchased at an authorized BRP dealership / distributor or on a BRP-authorized online store. Other exclusions may apply, see complete limited warranty or contact your Ski-Doo authorized dealer.

\*\* Unless otherwise stipulated or required by law.

This limited warranty does not apply to factory installed accessories. This limited warranty does not apply on Evinrude parts and accessories. This limited warranty is effective as of March 1<sup>st</sup> 2016.

OUR NEW SUMMIT. YOUR NEXT CLIMB

# WHAT MATTERS IS WHAT'S NEXT.

The next generation of Ski-Doo mountain sled accessories. Developed with the new generation REV platform to match perfectly, install easily and last for years.

- 
- 1 FOX FLOAT SHOCK GUARDS P. 156
  - 2 FULL BODY SKID PLATE P. 118
  - 3 HEAVY-DUTY BUMPER P. 120
  - 4 ERGO ADJUSTABLE TOE-HOLDS P. 125
  - 5 STACKABLE LINQ FUEL CADDY - 15 L P. 133
  - 6 LINQ SNOWBOARD/SKI RACK P. 134
  - 7 TRANSPARENT HANDLEBAR AIR DEFLECTORS P. 114
  - 8 HELIUM 30 JACKET & HIGHPANTS P. 18
  - 9 SKI-DOO XP-3 PRO CROSS SCARP HELMET P. 59
  - 10 SKI-DOO HELIUM GOGGLES BY SCOTT P. 62
  - 11 SKI-DOO TEC+ BOOTS P. 70
  - 12 OUTDRY HIGHMARK GLOVES P. 64



OUR NEXT MXZ. YOUR NEXT WASHBOARD TRAIL.

# WHAT MATTERS IS WHAT'S NEXT.

The next generation of Ski-Doo accessories. Make your next ride truly your own with accessories built just for the new generation REV platform.

- 
- 1 AUXILIARY LED LIGHT P. 115
  - 2 SIGNATURE LED LIGHT FOR HANDLEBAR AIR DEFLECTORS P. 115
  - 3 FULL BODY SKID PLATE P. 118
  - 4 XC 356T6 CAST BUMPER P. 120
  - 5 ERGO 2 STEP KNEE PADS P. 124
  - 6 ERGO LATERAL FOOTPLATES P. 125
  - 7 SR 21 L LinQ TUNNEL BAG P.132
  - 8 STACKABLE LinQ FUEL CADDY - 15 L P. 133
  - 9 GLOVEBOX EXTENSION / GPS SUPPORT P. 138
  - 10 X-TEAM JACKET & HIGHPANTS P. 30
  - 11 SKI-DOO XP-3 PRO CROSS X-TEAM HELMET P. 59
  - 12 SKI-DOO HOLESHOT GOGGLES BY SCOTT P. 63
  - 13 OUTDRY TRAIL PERFORMANCE GLOVES P. 66
  - 14 SKI-DOO TEC+ BOOTS P. 70

# CREATE YOUR CLIMATE WITH THE BRP PERFORMANCE RATING

We designed this Performance Rating System so you can easily choose and compare riding gear to find the ideal combination of performance and value for how you ride. Each riding gear garment has 3 performance ratings.



Look for these in the item descriptions throughout the catalog. On a 1 to 5 scale, 5 is the highest.



**WARMTH**  
This rating considers all aspects of the garment, including insulation, waterproofness, windproofness, breathability and fabric construction. Use it as your main criteria.



**WATERPROOF/WINDPROOF**  
This rating reflects the technology used, sealed seams, zipper types and more.



**BREATHABILITY**  
This rating indicates how effectively perspiration is moved away from your body and out of the garment.

## HOW TO CREATE YOUR CLIMATE

Mix outer layers (jackets and pants), mid layers and base layers to create a level of warmth that matches your riding style and natural body temperature.

Add up the **WARMTH** rating of each garment in each layer to get your system warmth total — the higher the number, the warmer the system.

Make sure you also consider your waterproof/windproof and breathability needs.

When building your system, be sure to consider your:

- RIDING STYLE** (active vs. relaxed)
- RIDING ENVIRONMENT** (mild vs. extreme cold)
- BODY TEMPERATURE** (do you run hot or chill easily?)

Examples of riding styles      Base Layer      Mid Layer      Outer Layer      Total **WARMTH** Rating

### VERY ACTIVE MOUNTAIN RIDER



### TOURING RIDER IN COLDER CONDITIONS

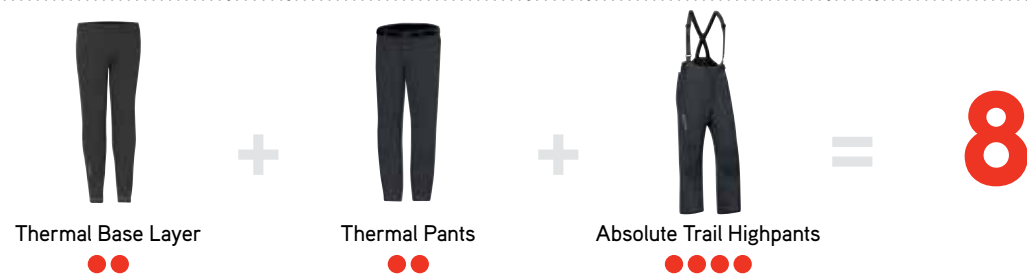

### ADD FLEXIBILITY WITH LAYERING

No matter which outer layer you choose, the mid layer is where you can really adapt your climate to the conditions — even as they change throughout the day.

For an extreme cold snap, consider adding a Packable Down Jacket, you could even also add the Heated Vest Liner.

When it's mild and you're using a lot of energy, you might go with no mid layer at all, just a good base layer.

### EXTREME COMBINATIONS

So, what are our warmest and coolest combinations for 2017?

Warmest	Coollest
Thermal Base Layer ●●	Ultralight Base Layer ●
+ Arctic Fleece ●●●●	(NO Mid Layer)
+ Heated Vest Liner ●●●●●● (on highest setting)	+ Helium Pullover Jacket ●●
+ Absolute 0 Jacket ●●●●●●	
= <b>15</b> Rating	= <b>3</b> Rating

## 2017 RIDING GEAR PERFORMANCE RATINGS

	Garment	Page	Warmth	Water/Windproof	Breathability	
<b>STEP 1 BASE LAYERS</b>	<b>Tops &amp; Bottoms</b>	Active Base Layer (Men's/Ladies')	p.46-48	●	●	●●●●●
		Ultralight Base Layer (Men's/Ladies')	p.46-48	●	●	●●●●●
		Thermal Base Layer (Men's/Ladies')	p.47-49	●●	●	●●●●●
		Thermal Pants	p.47	●●	●	●●●●●
<b>STEP 2 MID LAYERS</b>	<b>Tops &amp; Bottoms</b>	Packable Down Jacket (Men's/Ladies')	p.19-20	●●●●●	●●●●	●●●●●
		Tech Windproof Fleece Jacket	p.46	●●●●●	●●●●●	●●●●
		Tech Mid Layer Fleece (Men's/Ladies')	p.46-48	●●	●●	●●●●●
		MCode Mid Layer	p.46	●●	●	●●●●●
		Ski-Doo Zip Up Mid Layer	p.46	●●●●	●●	●●●●●
		Arctic Fleece	p.47	●●●●	●●	●●●●●
		Cozy Fleece Jacket	p.47	●●	●	●●●●●
		X-Team Microfleece (Men's/Ladies')	p.47-48	●●	●	●●●●●
		Sno-X Fleece	p.47	●●●●	●●	●●●●●
		Ladies' Muskoka Fleece	p.48	●●●●	●●	●●●●●
		Ladies' Supreme Fleece	p.49	●●●●	●●	●●●●●
		Ladies' Weekender Zip Up Sweater	p.48	●●	●	●●●●●
		Ladies' Polar Hoodie	p.49	●●	●	●●●●●
<b>STEP 3 OUTER LAYERS</b>	<b>Jackets</b>	Helium 50 Jacket	p.18	●●●●	●●●●●	●●●●●
		Helium 30 Jacket	p.18	●●	●●●●●	●●●●●
		Helium Pullover Jacket	p.19	●●	●●●●●	●●●●●
		Packable Down Jacket (Men's/Ladies')	p.19-20	●●●●●	●●●●	●●●●●
		Ladies' Helium 30 Jacket	p.20	●●	●●●●●	●●●●●
		Ladies' Helium Jacket	p.20	●●●●	●●●●●	●●●●●
		Revy One-Piece Suit	p.24	●●	●●●●	●●●●
		MCode Jacket with Insulation (Men's/Ladies')	p.24-25	●●●●●	●●●●	●●●●
		Helium Enduro Jacket	p.27	●●●●	●●●●●	●●●●●
		X-Team Winter Jacket	p.30	●●●●	●●●●	●●●●
		Ski-Doo Warnert Makita Race Edition Jacket	p.30	●●●●	●●●●	●●●●
		Ladies' X-Team Jacket	p.31	●●●●	●●●●	●●●●
		Sno-X Race Edition Shell	p.32	●●	●●●●●	●●●●●
		Warm-up Coat	p.32	●●●●	●●	●●
		Absolute 0 Jacket (Men's/Ladies')	p.38	●●●●●	●●●●●	●●●●●
		Absolute Trail Jacket	p.39	●●●●●	●●●●●	●●●●●
		Glide Jacket	p.40	●●●●●	●●●●	●●●●
		Glide LED Jacket	p.40	●●●●●	●●●●	●●●●
		Heated Vest Liner	p.40	●●●●●	●●	●●
		Ladies' Muskoka Jacket	p.41	●●●●●	●●●●	●●●●
Expedition Jacket	p.44	●●●●	●●●●	●●●●		
Holeshot Jacket	p.44	●●●●	●●	●●●●		
Track & Trail Jacket (Men's/Ladies')	p.44	●●●●	●●	●●●●		
<b>Pants</b>	Helium 50 Highpants	p.19	●●●●	●●●●●	●●●●●	
	Helium 30 Highpants	p.19	●●	●●●●●	●●●●●	
	Ladies' Helium Highpants	p.20	●●●●	●●●●●	●●●●●	
	MCode Pants (Men's/Ladies')	p.24-25	●●●●●	●●●●	●●●●	
	Helium Enduro Highpants	p.27	●●●●	●●●●●	●●●●●	
	X-Team Winter Highpants	p.30	●●●●	●●●●	●●●●	
	Ladies' X-Team Highpants	p.31	●●●●	●●●●	●●●●	
	Sno-X Race Edition Pants	p.32	●●	●●●●●	●●●●●	
	Absolute 0 Highpants (Men's/Ladies')	p.38	●●●●●	●●●●●	●●●●●	
	Absolute Trail Highpants	p.39	●●●●●	●●●●●	●●●●●	
Voyager Highpants (Men's/Ladies')	p.40-41	●●●●●	●●●●	●●●●		
Expedition Highpants	p.44	●●●●	●●●●	●●●●		
Trail Highpants (Men's/Ladies')	p.44	●●●●	●●	●●●●		

# TECHNOLOGY GUIDE

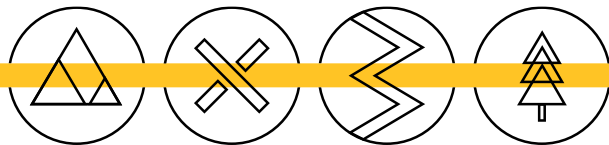

**THE MOST  
ADVANCED  
TECHNOLOGIES  
AND MATERIALS  
SO YOU'RE READY  
FOR WHAT'S NEXT.**



**Sympatex membrane**  
Waterproof/windproof/  
ultrabreathable membrane  
actually gets more breathable  
the harder you ride.



**Ski-Doo Riding Gear  
with Sympatex  
Lifetime Warranty**



**RPM**  
Provides maximum waterproofness,  
windproofness and breathability no matter  
how tough the ride or how cold the  
environment. Critical seams and logos sealed.



**Laminated  
Polyester Cordura**



**PrimaLoft**  
A high-performance  
insulation with the full  
spectrum of benefits  
to brave the elements.



**RPM MAX**  
Provides maximum waterproofness,  
windproofness and breathability no matter  
how tough the ride or how cold the  
environment. All seams and logos sealed.

▶ Learn everything about Riding Gear  
for Mountain Riders  
[www.ski-doo.com/genuine-parts-accessories-riding-gear/catalog-video](http://www.ski-doo.com/genuine-parts-accessories-riding-gear/catalog-video)



**HELIUM 50** P.18  
LIGHTWEIGHT AND TOUGH,  
YET HEAVY ON TECHNOLOGY.

- 1. Neoprene inner collar and microfleece inner ply
  - 2. Underarm and bicep venting
  - 3. Water-resistant zippers at front opening, pockets and vents
  - 4. 100% seams and logos sealed
  - 5. Sympatex' waterproof, windproof and breathable membrane
  - 6. Cordura' fabric for extra abrasion resistance
  - 7. Velcro' wrist adjustment
  - 8. Powder skirt
  - 9. Mid layer: Tech Mid Layer Fleece p.46
- Features not shown:**  
• Velcro adjustments at waist and hem



**ABSOLUTE 0** P.38  
THE WARMEST JACKET  
WE'VE EVER PRODUCED. PERIOD.

- 1. Removable and adjustable synthetic down collar
  - 2. PrimaLoft Gold insulation
  - 3. 100% seams and logos sealed
  - 4. Center front quadruple flaps with 2 offset zippers
  - 5. Sympatex waterproof, windproof and breathable membrane
  - 6. Shaped sleeves
  - 7. Underarm venting
  - 8. Removable liner
  - 9. Powder skirt
  - 10. Mid layer: Ski-Doo Zip up Mid Layer p.46
- Features not shown:**  
• Removable hood  
• Reflective detailing





**SYMPATEX WATERPROOF/WINDPROOF/OPTIMALLY BREATHABLE MEMBRANE ACTUALLY GETS MORE BREATHABLE THE HARDER YOU RIDE.**

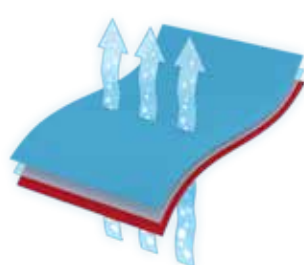

**OPTIMALLY BREATHABLE**  
Breathability will increase with heat and humidity

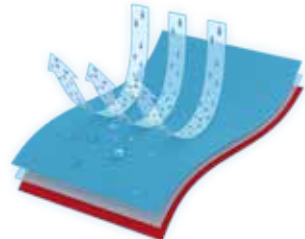

**100% WATERPROOF**  
Non porous membrane will never quit

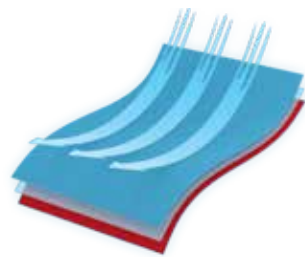

**100% WINDPROOF**  
Non porous, meaning that wind has no way of entering



Stretches to 300% of its size



Extremely durable and tough

**DID YOU KNOW** Gear with Sympatex doesn't have pores like other membranes and can be washed over and over without clogging or loss of performance.

**COMPARISON OF WATER VAPOUR TRANSPORT**

Function during increasing physical activity / sweating

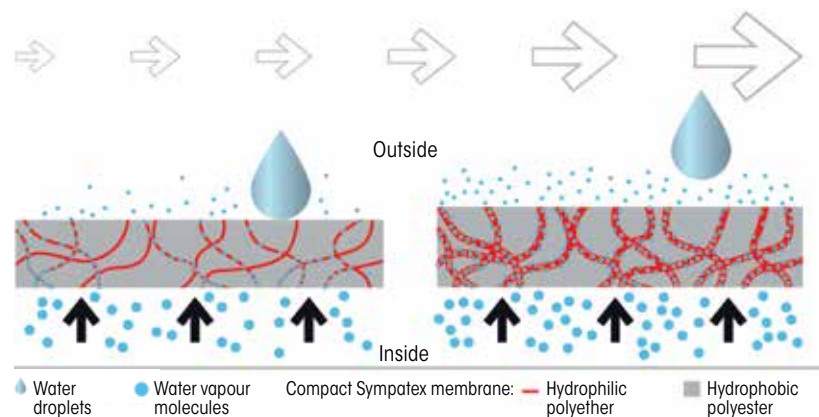

**MEMBRANE RESISTANCE**

A membrane is waterproof if it can resist a pressure of 1,300 mm. The Sympatex membrane is extremely waterproof since it can resist over 45,000 mm.

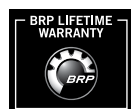
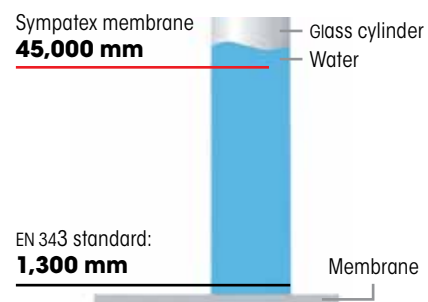

We believe so strongly in our Sympatex gear that we back it with a lifetime warranty. Go to [www.store.ski-doo.com/warranty](http://www.store.ski-doo.com/warranty) for details.

**WARRANTY COVERAGE PERIOD**  
Bombardier Recreational Products Inc. (BRP) warrants that all its 2017 Sympatex Riding Gear sold as New and Unused by an authorized North American BRP dealer will be free from any defect in material and / or workmanship for the lifetime of the product\*.

\* The lifetime of a product does not mean your lifetime. The intensity under which the product is used determines this factor. Rips, tears, punctures, holes and burns will void the product lifetime warranty even if the warranty issue is not related to these damages.



**A HIGH-PERFORMANCE INSULATION WITH THE FULL SPECTRUM OF BENEFITS TO BRAVE THE ELEMENTS.**

WARMER, DRIER, SOFTER AND MORE COMPRESSIBLE THAN ANY OTHER SYNTHETIC INSULATION

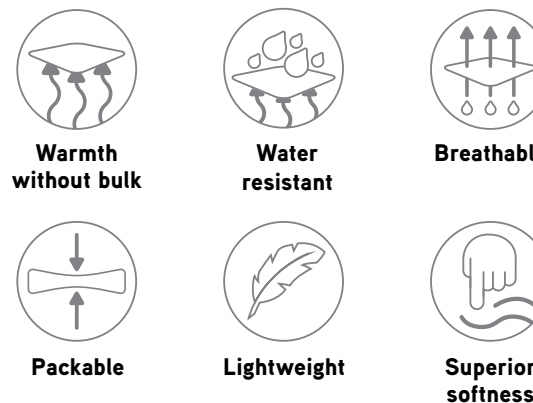

COMMITTED TO DELIVERING FEEL-GOOD PRODUCTS THAT EMPOWER YOU TO STAY IN THE MOMENT.



**GOLD INSULATION**

**Absolute O Jacket and Highpants** are insulated with PrimaLoft Gold for extreme warmth while staying soft and flexible. Our absolute warmest gear. p. 38



**SILVER INSULATION**

**Gilde Jacket** is insulated with PrimaLoft Silver for very good warmth and added flexibility. p. 40



**BLACK INSULATION**

**Absolute Trail Jacket and Highpants** use PrimaLoft Black insulation to give you the right amount of warmth and extra reathability. p. 39



**BLACK INSULATION DOWN BLEND**

**Packable Down Jackets** use the PrimaLoft Black Insulation Down Blend. A unique hybrid of water-repellent down and PrimaLoft superfine fibers. It combines the lightweight warmth, loft, packability and comfort of standard down, but with outstanding wet-weather thermal performance that even dries 4X faster, plus it's machine-washable. p. 19-20



**HIGH PERFORMANCE GEAR WITH RPM TECHNOLOGY**

Developed by BRP for snowmobilers like you, the RPM coating provides maximum protection no matter how tough the ride or how cold the environment.



**Holeshoot Jacket** with RPM coating p. 44

Critical seams and logos sealed



**MCode Jacket** with RPM MAX coating p. 24

All seams and logos sealed





OUR MOUNTAIN RIDING GEAR. YOUR DRY, WARM ADRENALINE RUSH.

# MOUNTAIN

LIGHTWEIGHT, WATERPROOF, BREATHABLE GEAR DESIGNED FOR MOUNTAIN RIDING.





## FEATURES

## BENEFITS

## PERFORMANCE RATINGS

## SIZES

## PRICE

<p><b>HELIUM 50</b> JACKET 440699</p>		<p><b>P. 18</b></p> <p><b>SHELL</b> Sympatex 3-Ply Laminated Polyester</p>   	<ul style="list-style-type: none"> <li>• 100% seams and logos sealed.</li> <li>• Waterproof, windproof and breathable membrane.</li> <li>• Water-resistant zippers at front opening, pockets and vents.</li> <li>• Powder skirt.</li> <li>• Underarm and bicep venting.</li> </ul> <ul style="list-style-type: none"> <li>• Neoprene inner collar and microfleece inner ply.</li> <li>• Velcro wrist adjustment and adjustment at waist and hem.</li> <li>• Durable Cordura fabric.</li> </ul>	<ul style="list-style-type: none"> <li>• Keeps you dry and warm all day.</li> <li>• Keeps snow out in even the deepest powder.</li> <li>• Becomes more breathable the harder you ride, for comfort.</li> <li>• Backpack friendly.</li> </ul>		<p>XS, S, M, L, XL, 2XL, 3XL</p>	<p><b>\$499.99</b></p>
<p><b>HELIUM 50</b> HIGHPANTS 441549</p>		<p><b>P. 19</b></p> <p><b>SHELL</b> Sympatex 3-Ply Laminated Polyester</p>   	<ul style="list-style-type: none"> <li>• 100% seams and logos sealed.</li> <li>• Waterproof, windproof and breathable membrane.</li> <li>• Stretch fabric at waist and storm gaiters.</li> <li>• High front and back bib panels.</li> <li>• Lightweight fleece and mesh inner liner at front and seat.</li> </ul> <ul style="list-style-type: none"> <li>• Removable knee and shin pads.</li> <li>• 2-way front and full-length water-resistant side curved zippers.</li> <li>• Zippered hip and front pockets.</li> </ul>	<ul style="list-style-type: none"> <li>• Keeps you dry and warm all day.</li> <li>• Become more breathable the harder you ride, for comfort.</li> <li>• Keeps snow out in even the deepest powder.</li> <li>• Lightweight, comfortable and easy to get into and out of.</li> <li>• Curved zipper will prevent bunching.</li> </ul>		<p>XS, S, M, L, XL, 2XL, 3XL</p>	<p><b>\$439.99</b></p>
<p><b>HELIUM 30</b> JACKET 440693 • 440700</p>		<p><b>P. 18</b></p> <p><b>SHELL</b> Sympatex 2-Ply Laminated Polyester</p>   	<ul style="list-style-type: none"> <li>• 100% seams and logos sealed.</li> <li>• Waterproof, windproof and breathable membrane.</li> <li>• Water-resistant zippers at front opening, pockets and vents.</li> <li>• Powder skirt.</li> <li>• Underarm and bicep venting.</li> <li>• Removable hood.</li> </ul>	<ul style="list-style-type: none"> <li>• Keeps you dry and warm all day.</li> <li>• Becomes more breathable the harder you ride, for comfort.</li> <li>• Backpack friendly.</li> </ul>		<p>XS, S, M, L, XL, 2XL, 3XL</p> <p>Tall sizes MT, LT, XLT, 2XLT</p>	<p><b>\$379.99</b></p> <p>Tall sizes <b>\$399.99</b></p>
<p><b>HELIUM 30</b> HIGHPANTS 441548 • 441561</p>		<p><b>P. 19</b></p> <p><b>SHELL</b> Sympatex 2-Ply Laminated Polyester</p>   	<ul style="list-style-type: none"> <li>• 100% seams and logos sealed.</li> <li>• Waterproof, windproof and breathable membrane.</li> <li>• High front and back bib panels.</li> <li>• Stretch fabric at waist.</li> <li>• Storm gaiters.</li> </ul> <ul style="list-style-type: none"> <li>• Lightweight fleece and mesh inner liner at front and seat.</li> <li>• Removable knee and shin pads.</li> <li>• 2-way front and full-length water-resistant side curved zippers.</li> <li>• Zippered hip and front pockets.</li> </ul>	<ul style="list-style-type: none"> <li>• Keeps you dry and warm all day.</li> <li>• Become more breathable the harder you ride, for comfort.</li> <li>• Keeps snow out in even the deepest powder.</li> <li>• Easy to get into and out of.</li> </ul>		<p>XS, S, M, L, XL, 2XL, 3XL</p> <p>Tall sizes MT, LT, XLT, 2XLT</p>	<p><b>\$369.99</b></p> <p>Tall sizes <b>\$389.99</b></p>
<p><b>HELIUM PULLOVER</b> JACKET 440666</p>		<p><b>P. 19</b></p> <p><b>SHELL</b> Sympatex 2-Ply Laminated Polyester</p>   	<ul style="list-style-type: none"> <li>• 100% seams and logos sealed.</li> <li>• Waterproof, windproof and breathable membrane.</li> <li>• Water-resistant zippers.</li> <li>• Underarm venting.</li> <li>• Tough polyester shell with mesh lining.</li> </ul>	<ul style="list-style-type: none"> <li>• Keeps you dry and warm all day.</li> <li>• Becomes more breathable the harder you ride, for comfort.</li> </ul>		<p>XS, S, M, L, XL, 2XL, 3XL</p>	<p><b>\$289.99</b></p>

			FEATURES	BENEFITS	PERFORMANCE RATINGS	SIZES	PRICE
PACKABLE DOWN JACKET 440749 • 440750	 Men's Ladies'	P. 19-20 SHELL Nylon, Polyester 	<ul style="list-style-type: none"> <li>Use as a light jacket for cool dry weather or as a mid layer.</li> <li>Water-repellent treatment on down feathers.</li> <li>Drawcord hem adjustment in pockets.</li> <li>Microfleece underarm vents.</li> <li>Shaped sleeves.</li> </ul>	<ul style="list-style-type: none"> <li>Lightweight and packable.</li> <li>Warm even when wet.</li> <li>Breathable to keep you dry.</li> <li>Temperature regulation.</li> </ul>		Men's S, M, L, XL, 2XL, 3XL  Ladies' XS, S, M, L, XL, 2XL, 3XL	Men's \$184.99  Ladies' \$184.99
LADIES' HELIUM 30 JACKET 440695		P. 20 SHELL Sympatex 2-Ply Laminated Polyester 	<ul style="list-style-type: none"> <li>100% seams and logos sealed.</li> <li>Waterproof, windproof and breathable membrane.</li> <li>Water-resistant zippers at front opening and pockets.</li> <li>Powder skirt.</li> <li>Underarm venting.</li> <li>Removable hood.</li> <li>Added reflective detailing for optimal visibility.</li> </ul>	<ul style="list-style-type: none"> <li>Women's cut and fit.</li> <li>Lightweight and flexible.</li> <li>Keeps you dry and warm all day.</li> <li>Becomes more breathable the harder you ride, for comfort.</li> <li>Keeps snow out even in the deepest powder.</li> </ul>		XS, S, M, L, XL, 2XL, 3XL	\$359.99
LADIES' HELIUM JACKET 440583		P. 20 SHELL Sympatex 3-Ply Laminated Polyester 	<ul style="list-style-type: none"> <li>100% seams and logos sealed.</li> <li>Waterproof, windproof and breathable membrane.</li> <li>Water-resistant zippers at front opening and pockets.</li> <li>Powder skirt.</li> <li>Side venting.</li> <li>Stretch fabric inserts for ease of movement.</li> </ul>	<ul style="list-style-type: none"> <li>Women's cut and fit.</li> <li>Lightweight and flexible.</li> <li>Keeps you dry and warm all day.</li> <li>Becomes more breathable the harder you ride, for comfort.</li> <li>Keeps snow out even in the deepest powder.</li> </ul>		XS, S, M, L, XL, 2XL, 3XL	\$399.99
LADIES' HELIUM HIGHPANTS 441493		P. 20 SHELL Sympatex 3-Ply Laminated Polyester 	<ul style="list-style-type: none"> <li>100% seams and logos sealed.</li> <li>Waterproof, windproof and breathable membrane.</li> <li>Stretch fabric at waist, crotch and upper knees.</li> <li>Designed with high front and back bib panels.</li> <li>2-way full-length water-resistant side zippers.</li> <li>Integrated removable knee pads.</li> <li>Storm gaiters.</li> <li>Water-resistant front zipper.</li> </ul>	<ul style="list-style-type: none"> <li>Keeps you dry and warm all day.</li> <li>Keeps snow out even in the deepest powder.</li> <li>Women's cut for a comfortable fit, easy to get into and out of.</li> <li>Become more breathable the harder you ride, for comfort.</li> </ul>		XS, S, M, L, XL, 2XL, 3XL	\$389.99
MCODE JACKET WITH INSULATION 440724 • 440723	 Men's Ladies'	P. 24-25 SHELL Polyester, Nylon 	<ul style="list-style-type: none"> <li>3-in-1 jacket that can be worn as shell, shell + insulated liner, liner alone.</li> <li>100% seams and logos sealed.</li> <li>Waterproof, windproof and breathable.</li> <li>Water-resistant zippered pockets.</li> <li>Powder skirt.</li> <li>Shaped sleeves with adjustable hem and wrists.</li> <li>Underarm venting.</li> <li>Removable hood and inner removable quilted jacket.</li> <li>Integrated inner Lycra® wrist with thumb.</li> </ul>	<ul style="list-style-type: none"> <li>Keeps you dry and warm all day.</li> <li>Keeps snow out even in the deepest powder.</li> <li>3-in-1 design to adapt to conditions.</li> </ul>		Men's XS, S, M, L, XL, 2XL, 3XL  Ladies' XS, S, M, L, XL, 2XL, 3XL	Men's \$309.99  Ladies' \$309.99
MCODE PANTS 441575 • 441576	 Men's Ladies'	P. 24-25 SHELL Polyester, Nylon 	<ul style="list-style-type: none"> <li>100% seams and logos sealed.</li> <li>Waterproof, windproof and breathable.</li> <li>Water-resistant waist and thigh pockets.</li> <li>Lightly insulated and full-length side zippers.</li> <li>Storm gaiters.</li> <li>Back suspender divider to avoid slipping off.</li> <li>Removable suspender system.</li> <li>Adjustable waist.</li> <li>Shaped knees.</li> <li>Fleece lined seat.</li> <li>Jacket-to-pants attachment system.</li> </ul>	<ul style="list-style-type: none"> <li>Keeps you dry and warm all day.</li> <li>Light insulation keeps you warm.</li> <li>Easy to get into and out of.</li> </ul>		Men's XS, S, M, L, XL, 2XL, 3XL  Ladies' XS, S, M, L, XL, 2XL, 3XL	Men's \$229.99  Ladies' \$229.99
REVVY ONE-PIECE SUIT 440667		P. 24 SHELL Nylon, Polyester 	<ul style="list-style-type: none"> <li>100% seams and logos sealed.</li> <li>Waterproof, windproof and breathable.</li> <li>Water-resistant zippers.</li> <li>Removable hood.</li> <li>Shaped sleeves and knees.</li> <li>Adjustable wrists, waist and inner suspender system.</li> <li>Storm gaiters.</li> <li>Oversized thigh pockets.</li> </ul>	<ul style="list-style-type: none"> <li>Rad look that gives you freedom of movement and no snow intrusion.</li> <li>Keeps you dry and warm all day.</li> <li>Adjustments enable you to get just the right fit.</li> </ul>		XS, S, M, L, XL, 2XL, 3XL	\$499.99



5 3 4

**PACKABLE DOWN JACKET**

An ideal mid layer for active riders. Down insulation compresses to take very little room in your pack or storage compartment.

**Shell:** 90% Nylon, 10% Polyester  
**Insulation:** 50% PrimaLoft Ultrafine Fibers, 50% PrimaLoft Black Insulation Down Blend

440749 • S, M, L, XL, 2XL, 3XL  
 Orange (12), Black (90)

**\$184.99**



See the features of the Packable Down Jacket.  
[www.ski-doo.com/genuine-parts-accessories-riding-gear/catalog-video](http://www.ski-doo.com/genuine-parts-accessories-riding-gear/catalog-video)



2 5 5

**HELIUM 30 JACKET**

A radically lightweight and flexible jacket for the most active riders. Keeps you warm and dry thanks to Sympatex technology.

**Shell:** Sympatex 2-Ply Laminated Polyester

440693 • XS, S, M, L, XL, 2XL, 3XL  
 Orange (12), Hi-Vis Yellow (26), Blue (80), Black (90)

**\$379.99**

Tall sizes

440700 • MT, LT, XLT, 2XLT  
 Black (90)

**\$399.99**

3 5 5

**HELIUM 50 HIGHPANTS**

Robust Cordura fabric and Sympatex technology combine for tough yet flexible and comfortable highpants. Jointly designed with top mountain riders for just the right fit.

**Shell:** Sympatex 3-Ply Laminated Polyester

441549 • XS, S, M, L, XL, 2XL, 3XL  
 Black (90)

**\$439.99**



Learn everything about the technology built into the Helium 50 Highpants.  
[www.ski-doo.com/genuine-parts-accessories-riding-gear/catalog-video](http://www.ski-doo.com/genuine-parts-accessories-riding-gear/catalog-video)



Our Helium Highpants feature curved zippers on outer leg to prevent bunching of the material.

2 5 5

**HELIUM 30 HIGHPANTS**

Riding pants for active riders with Sympatex technology to protect you from wet and cold conditions. Our lightest, most flexible highpants.

**Shell:** Sympatex 2-Ply Laminated Polyester

441548 • XS, S, M, L, XL, 2XL, 3XL  
 Orange (12), Black (90)

**\$369.99**

Tall sizes

441561 • MT, LT, XLT, 2XLT  
 Black (90)

**\$389.99**



3 5 5

**HELIUM 50 JACKET**

Built with the best and most innovative materials, the Helium 50 is our toughest and highest performing jacket for the most active riders.

**Shell:** Sympatex 3-Ply Laminated Polyester

440699 • XS, S, M, L, XL, 2XL, 3XL  
 Hi-Vis Yellow (26), Black (90)

**\$499.99**



2 5 5

**HELIUM PULLOVER JACKET**

The most lightweight shell in our lineup, feels like wearing no shell at all. Innovative materials deliver breathability, performance and durability for mountain riding.

**Shell:** Sympatex 2-Ply Laminated Polyester

440666 • XS, S, M, L, XL, 2XL, 3XL  
 Orange (12), Hi-Vis Yellow (26), Black (90)

**\$289.99**

The Sympatex membrane stretches to 300% of its size, so it maintains its properties in high bending areas, like elbows and knees.





**LADIES' PACKABLE DOWN JACKET**  
 An ideal mid layer for active riders, styled with a women's cut. Down insulation compresses to take very little room in your pack or storage compartment.

**Shell:** 90% Nylon, 10% Polyester  
**Insulation:** 50% PrimaLoft Ultrafine Fibers, 50% PrimaLoft Black Insulation Down Blend

440750 • XS, S, M, L, XL, 2XL, 3XL  
 Grey (09), Black (90)  
**\$184.99**

See the features of the Packable Down Jacket.  
[www.ski-doo.com/genuine-parts-accessories-riding-gear/catalog-video](http://www.ski-doo.com/genuine-parts-accessories-riding-gear/catalog-video)

**HELIUM 30 JACKET**  
 Advanced technology and performance in a lightweight shell designed for women riders.

**Shell:** Sympatex 2-Ply Laminated Polyester

440695 • XS, S, M, L, XL, 2XL, 3XL  
 Charcoal Grey (07)  
**\$359.99**

**HELIUM HIGHPANTS**  
 Designed specifically for women. Feminine fit and super lightweight fabric. Waterproof, windproof and ultra breathable thanks to Sympatex technology.

**Shell:** Sympatex 3-Ply Laminated Polyester

441493 • XS, S, M, L, XL, 2XL, 3XL  
 Black (90)  
**\$389.99**

**HELIUM JACKET**  
 Advanced technology and performance in a lightweight shell designed for women riders.

**Shell:** Sympatex 3-Ply Laminated Polyester

440583 • XS, S, M, L, XL, 2XL, 3XL  
 White (01)  
**\$399.99**



THE MOST RESPONSIVE RIDING GEAR

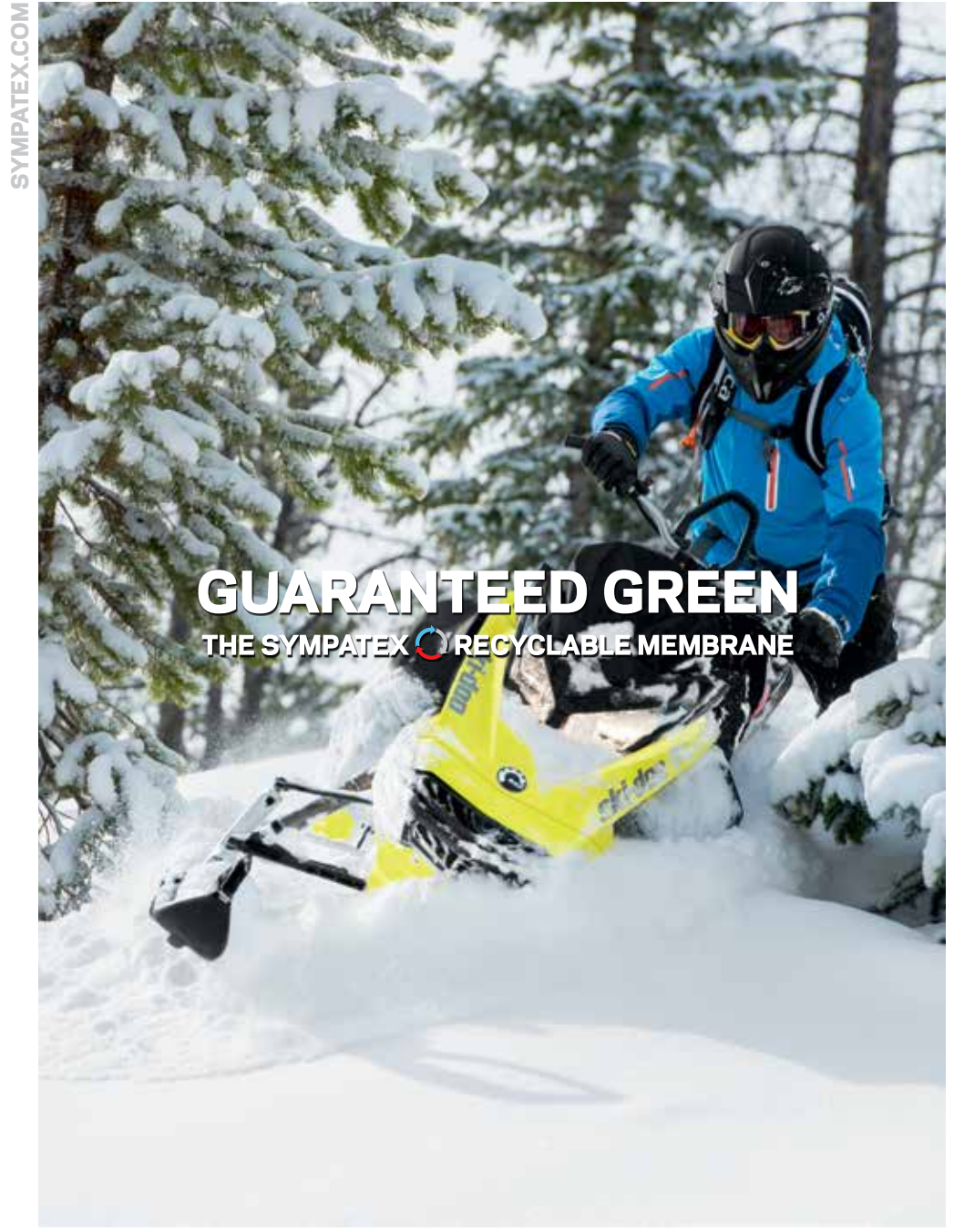

**GUARANTEED GREEN**  
 THE SYMPATEX RECYCLABLE MEMBRANE

DYNAMIC PERFORMANCE



**WATERPROOF BREATHABLE WINDPROOF**

SEE MOUNTAIN OUTER LAYER FEATURES & BENEFITS P. 14-17

READ ABOUT WOMEN RIDERS SHREDDING THEIR OWN LINES ON P.81

# GOOD HABITS FOR AVALANCHE TERRAIN

So your group has taken some sort of avalanche training... maybe attended one of the seminars at a Ski-Doo dealer that BRP puts on. Awesome. Now it's time to get in the habit of practicing what you learned every time you head out into the backcountry.

by **Jeremy Mercier**,  
Ski-Doo Backcountry Expert

## Here are habits I've ingrained to ride as safely as I can:

### Check the weather forecast.

Rapid rises in temperature, heavy snowfalls and wind can have drastic impacts on the snowpack. You're considering: which slope got loaded by wind last night? What was the temperature? How much snow fell?

### Check the backcountry

**avalanche forecast.** Go to the top website in your country – [www.avalanche.org](http://www.avalanche.org) in the US and [www.avalanche.ca](http://www.avalanche.ca) in Canada. This information is especially important if you haven't seen the conditions in person lately. Don't be afraid to ask locals as well.

### Do a transceiver check.

Before we leave the parking lot, everyone makes sure their transceiver is working and has enough battery life. This is a MUST DO. You also need to practice transceiver searches with your group a few times a year. Have a party.

### Do a radio check.

I started using FRS radios with my riding buddies and I won't ride without them again. You can quickly get a hold of people if something happens. Plus, you don't waste riding time tracking down your buddy who took off over that ridge.

### Come up with a plan and

**stick to it.** Discuss what type of terrain you're heading into and what is safe to ride for that particular zone. Evaluate the snowpack when you get out there and decide if you're going to continue. And don't succumb to peer pressure. There's no need to risk an avalanche just to get that great shot or footage for your social media page.

### Start on low angle terrain.

Then migrate towards steeper terrain if the snowpack allows.

**Never lose contact with the group.** Either keep your eye on your group or maintain radio contact.

I know this sounds like a lot of stuff. But if you commit to doing these, they'll just become a habit and you won't even think about them after a while. Finally, keep up the education. Organizations like the Canadian Avalanche Centre, American Avalanche Association and Avalanche 1 keep adding to our knowledge of avalanches. And the increased educational opportunities – like BRP's free Avalanche Awareness Seminars – have been reducing snowmobile fatalities significantly.



## BRP AVALANCHE AWARENESS SEMINARS

For the past three years, more than 12,000 snowmobilers have attended free avalanche safety seminars sponsored by BRP and hosted by Ski-Doo dealers across North America. Open to snowmobilers of all brands, these cover the basics of avy safety in an effort to keep backcountry snowmobilers safe. For the schedule of 2016-2017 seminars, go to [www.ski-doo.com](http://www.ski-doo.com).



**Jeremy Mercier** is a Ski-Doo Backcountry Expert riding out of Colorado. He's been playing in the mountains for more than 20 years (including operating a snowmobile and snowboard riding camp) and has a Level 2 Avalanche Certification from Silverton Avalanche School, the longest running school in the country.

### Follow Jeremy:

[f jeremy.mercier.7](https://www.facebook.com/jeremy.mercier.7)  
[i mercier4colorado](https://www.instagram.com/mercier4colorado)

# PREPPING A 3-DAY BLITZ RIDE

Some of the best snowmobiling happens during three day blitz rides. These are sometimes known as "toothbrush trips," because that's all you really need to take with you? Typically, you would depart Thursday night and return late Sunday, after doing as much sledding as your group wants. Here's how I get ready for a blitz ride.

By **Craig Nicholson**,  
The Intrepid Snowmobiler

## Choose your destination

Start with a location that's close enough to reach that first night after work. Then consider truck and trailer parking, nearby services and direct trail access. In locations with lots of trail options, you can use one home base and not carry your overnight items on your rides. Other times, you'll ride one large point-to-point loop with overnight stops. Backcountry riding along the way is always a great bonus. Obtain the applicable trail maps several weeks ahead to familiarize yourself with your destination and routes...and to make advance reservations for lodging on busy weekends.

## Prep the sleds

Before leaving, make sure all sleds, tow vehicles and trailers are in good shape and ready. Fuel them up and fill the oil reservoirs on the 2-stroke sleds. The night before departure, pack extra oil for top-ups, the owner's manual, toolkit, spare BRP belt, spark plugs, fuses and emergency kit. Then load them on the trailer.

## Pack your bags

There's one rule for what else to pack for a blitz ride: not much. You can wear the same clothes for trailering there and back, leaving them in your truck while you're riding. That means just carrying one set of sportswear for two nights, dressing in the same attire twice. Along with a change of underwear or two and minimal toiletries (the toothbrush!), you can easily fit your necessities into a LinQ Medium Tunnel Bag and Saddlebags. There's even room for a lightweight Racing Storage Cover to protect your sled from snow and frost each night.

Don't forget cash, credit cards and whatever license, registration, trail permits and proof of insurance you may need. You can also gather your smartphone, charger and other personal items like sunglasses.

## Make a list, check it twice

Print a checklist and pack everything – including your riding gear, technical base and mid layers – mark each item off the list. Set your bag by the door with your helmet in its helmet bag, so you pretty much have to trip over them when leaving. This way, no critical riding gear gets left behind.

Before leaving, email your riding companions so everyone (especially spouses staying at home) know exactly when you're departing, where you're staying, what days you intend to ride and when your return is planned.

**NOW LET YOUR BLITZ RIDE BEGIN!**



The Intrepid Snowmobiler **Craig Nicholson** is a freelance journalist specializing in motorized recreational activities, including snowmobiling. As an avid snowmobiler, he logs up to 10,000 miles (15,000 km) on the snow each winter and has snowmobiled in every region of Canada. He has published a one-of-a-kind tour book, "Canada's Best Snowmobiling – The Ultimate Ride Guide," has a syndicated column and radio show and is a regular contributor to SnowGoer Canada and Snowmobiler TV. His current sled is a Ski-Doo Renegade.



4 3 3

**MCODE JACKET WITH INSULATION**

A versatile 3-in-1 jacket with modern styling and colors. Mix and match with MCode Pants.

Shell: 65% Polyester, 35% Nylon  
 Insulation: PrimaLoft Black  
 440724 • XS, S, M, L, XL, 2XL, 3XL  
 Camo (37), Green (70)

**\$309.99**



**DID YOU KNOW**

Helium and M-Code gear is developed with feedback from mountain freeriders

4 3 3

**MCODE PANTS**

Fresh modern design in lightly insulated pants. Pair perfectly with MCode Jackets, especially when you mix and match for your own look.

Shell: 75% Polyester, 25% Nylon  
 Insulation: PrimaLoft Black

441575  
 XS, S, M, L, XL, 2XL, 3XL  
 Camo (37), Black (90)

**\$229.99**



2 3 3

**REVV ONE-PIECE SUIT**

You'll never feel so free and ready to take on any amount of powder with this roomy, high performing and high style suit.

Shell: 84% Nylon, 16% Polyester

440667  
 XS, S, M, L, XL, 2XL, 3XL  
 Blue (80), Sunburst Yellow (96)

**\$499.99**



4 3 3

**MCODE JACKET WITH INSULATION**

A versatile 3-in-1 jacket with modern styling and colors. Unique fit, style and colors for women riders.

Shell: 60% Polyester, 40% Nylon  
 Insulation: PrimaLoft Black

440723 • XS, S, M, L, XL, 2XL, 3XL  
 Pink (36), Teal (74)

**\$309.99**



4 3 3

**MCODE PANTS**

Fresh modern design in lightly insulated pants. Pair perfectly with MCode Jackets, especially when you mix and match for your own look. Women-specific fit and colors.

Shell: 95% Polyester, 5% Nylon  
 Insulation: PrimaLoft Black

441576 • XS, S, M, L, XL, 2XL, 3XL  
 Camo (37), Black (90)

**\$229.99**



# THE CROSSOVER BOOM

If you've been snowmobiling the past few years, you've surely noticed more and more crossover sleds out there. Crossover is currently the fastest growing segment in snowmobiling. What's behind this trend?

We see two main reasons. First, there are **benefits to a longer suspension on trail**. When we first launched the Renegade, we envisioned midwesterners buying it for riding trails at home and then trailering it out West for their trips to ride deep snow. In fact, the first one was the Summit Renegade.

"I switched to a Renegade from an MXZ to be able to enjoy backcountry riding as well as have a comfortable ride on the trail," said Corey Haas on Facebook. "It makes each trip an adventure when you don't have to limit yourself to just one type of riding. I ride in the U.P. of Michigan as well as West Yellowstone."

Like Corey, while riders appreciated the added off-trail capability, they really liked the improved performance and comfort on trail. The longer suspension bridged bumps for comfort, added traction and for larger riders, felt more planted.

Second, **snowmobile innovation and technology** have made riding off-trail so much easier. Sleds are lighter, the riding position makes it easier to boondock, the tracks are so much better. The suspensions are just so good there's little to no compromise in trail cornering. Fuel efficiency is good so you can stay out and play longer.

So now, you can get a crossover sled with the capability to carve up trails and carve up fresh snow in a meadow, to confidently break trail after a dump and have a blast freeriding – even head out for a multi-day tour. You can do a lot with just one sled.

This versatility is the key to the crossover boom.

"But the growing appeal of the Renegade has created a new challenge," says Jimmy Coté, Ski-Doo product manager. "When you have a sled that can be used so many ways, riders now want that sled a bit more specialized for how they ride. Some will ride only once or twice a season off-trail. Others want a hot trail ride and then freeride for a few hours."

BRP has this covered with three types of 2017 Renegade sleds:

The **Renegade X-RS**, **Renegade X**, **Renegade Adrenaline** and **Renegade Sport** are primarily equipped for trail riding – maybe breaking trail and playing in deeper snow once in awhile.

The **Renegade Backcountry** sleds are more like the original Summit Renegade, about a 60%-40% bias towards off-trail riding. For those that want the freedom and exploration of western deep snow riding in lower altitude areas and still have a fun time on the trails.

The **Renegade Enduro** is the class of the growing premium adventure sub-segment. You get the versatility of a trail-oriented Renegade but with features for more capability and more comfort, such as the Air Ride suspension, Pilot TS adjustable skis and a heated seat. It's as much at home on a multi-day vacation as a weekend bash through single-track.

As Renegade buyers want to customize their sled even further, we offer a huge range of accessories enabling you to do just that. Think LinQ system bags, the unrivalled 1+1 seat system, skid plates, adjustable risers, Garmin GPS system, LED Auxiliary lights and ice scratchers to name a few.

And we even have taken this versatility to a clothing line for Renegade riders. Helium Enduro gear is ultra flexible and breathable while totally waterproof and windproof for comfort in active off-trail riding. But unlike our mountain gear, it has a light insulation for warmth in colder temperatures and more relaxed trail riding.

Crossover sleds go way back to the early days of snowmobiling where you could ride almost anywhere in any way on your Olympic and have fun. This freedom drove snowmobiling to incredible heights then and is driving excitement today with the Renegade sleds.

YOUR NEXT CRUISE THROUGH RUGGED TERRAIN.

## CROSSOVER

GEAR THAT'S A CROSS BETWEEN OUR TOP MOUNTAIN AND TRAIL TECHNOLOGIES.



### HELIUM ENDURO JACKET

Ultra high performance jacket with mid-weight insulation to keep you warm and dry, whether you're carving up trails, exploring the woods or in open space.

- Waterproof, windproof, breathable membrane.
- 100% seams and logos sealed.
- Water-resistant zippers at front, pockets and vents.
- Microfleece inner collar.
- Easy-to-reach bicep vents.
- Powder skirt.
- Hem, collar and wrist adjustments.
- Inner microfleece cuffs.
- Silicone grips at shoulder to stabilize a backpack.
- Wide reflective features for better visibility.
- Reinforced elbows and back hem for durability.

**Shell:** Sympatex 2-Ply Laminated Polyester  
**Insulation:** PrimaLoft Black

440744 • XS, S, M, L, XL, 2XL, 3XL  
Black (90)

**\$399.99**



### HELIUM ENDURO HIGHPANTS

For the rider who wants to do it all, on and off trail. Mid-weight insulation, Sympatex technology and lots of features to keep you comfortable.

- Full-length 2-way waterproof side zippers.
- Front 2-way zipper.
- Shaped knees.
- Padded and reinforced inner legs.
- Storm gaiters.
- Adjustable suspenders.
- Waterproof hip pockets.
- Chest and cargo pockets.

**Shell:** Sympatex 2-Ply Laminated Polyester  
**Insulation:** PrimaLoft Black

441593 • XS, S, M, L, XL, 2XL, 3XL  
Black (90)

**\$379.99**



OUR TRAIL PERFORMANCE GEAR. YOUR NEXT HEAT RACE.

# TRAIL PERFORMANCE



## FEATURES

## BENEFITS

## PERFORMANCE RATINGS

## SIZES

## PRICE

<p><b>X-TEAM</b> WINTER JACKET 440720 • 442428 • 442432 • 440721</p>	 <p><b>P. 30-31</b></p> <p>Men's Ladies' Ski-Doo Warnert Makita Race Edition Jacket 440728</p>	<p><b>SHELL</b> Men's: Polyester/Nylon Ladies': Polyester/Nylon</p> 	<ul style="list-style-type: none"> <li>• 100% seams and logos sealed.</li> <li>• Adjustable collar, hem and wrists.</li> <li>• Reflective detailing.</li> <li>• Shaped sleeves and articulated shoulders.</li> <li>• Triple front flaps construction.</li> <li>• Powder skirt.</li> </ul> <p><u>Ski-Doo Warnert Makita Race Edition Jacket</u></p> <ul style="list-style-type: none"> <li>• Front double flaps.</li> </ul> <p><b>Men's</b></p> <ul style="list-style-type: none"> <li>• Underarm and back venting.</li> <li>• Integrated inner Lycra wrist and reinforced fabric at elbows and back hem.</li> </ul> <p><b>Ladies'</b></p> <ul style="list-style-type: none"> <li>• Underarm venting.</li> <li>• Removable hood.</li> </ul>	<ul style="list-style-type: none"> <li>• Warm jacket for trail riding.</li> <li>• Keeps you dry and warm all day.</li> <li>• Designed to move with you when riding.</li> <li>• Highly visible.</li> </ul>		<p><b>Men's</b> XS, S, M, MT, L, LT, XL, XLT, 2XL Tall sizes: 2XLT, 3XL, 3XLT, 4XL, 5XL <b>Ladies'</b> XS, S, M, L, XL, 2XL, 3XL</p>	<p><b>Men's</b> \$319.99 Tall sizes \$339.99 <b>Ladies'</b> \$309.99 Ski-Doo Warnert Makita Race Edition \$369.99</p>
<p><b>X-TEAM</b> WINTER HIGHPANTS 441573 • 441577 • 441574</p>	 <p><b>P. 30-31</b></p> <p>Men's Ladies'</p>	<p><b>SHELL</b> Polyester/Nylon</p> 	<ul style="list-style-type: none"> <li>• Fully-insulated highpants.</li> <li>• Waterproof, windproof and breathable.</li> <li>• 100% seams and logos sealed.</li> <li>• Adjustable waist.</li> <li>• Storm gaiters.</li> </ul> <p><u>Ladies'</u></p> <ul style="list-style-type: none"> <li>• Flapped side zippers.</li> </ul> <p><b>Men's</b></p> <ul style="list-style-type: none"> <li>• Full-length water-resistant side zippers.</li> <li>• Articulated, padded, shaped knees and adjustable suspenders.</li> <li>• Water-resistant zippers at pockets and vents and reinforced crotch.</li> </ul>	<ul style="list-style-type: none"> <li>• Warm for trail riding.</li> <li>• Race-team styling.</li> <li>• Easy to get into and out of.</li> <li>• Keeps you dry and warm all day.</li> <li>• Designed to move with you when riding.</li> </ul>		<p><b>Men's</b> XS, S, M, L, XL, 2XL Tall sizes: MT, LT, XLT, 2XLT, 3XL, 3XLT, 4XL, 4XLT, 5XL <b>Ladies'</b> XS, S, M, L, XL, 2XL, 3XL</p>	<p><b>Men's</b> \$279.99 Tall sizes \$289.99 <b>Ladies'</b> \$249.99</p>
<p><b>WARM-UP COAT</b> 440703</p>	 <p><b>P. 32</b></p>	<p><b>SHELL</b> Polyester/Nylon</p> 	<ul style="list-style-type: none"> <li>• Insulated pre-race overcoat.</li> <li>• Waterproof and windproof.</li> <li>• Removable hood fits over Ski-Doo snocross helmet.</li> <li>• Large pockets.</li> </ul>	<ul style="list-style-type: none"> <li>• Full overcoat-style coverage to keep wind and cold out.</li> <li>• Keeps you dry and warm all day.</li> <li>• Versatility for racers or spectators.</li> </ul>		<p>One size</p>	<p>\$279.99</p>
<p><b>SNO-X RACE EDITION</b> SHELL 440722</p>	 <p><b>P. 32</b></p>	<p><b>SHELL</b> Sympatex 2-Ply Laminated Polyester</p>  	<ul style="list-style-type: none"> <li>• 100% seams and logos sealed.</li> <li>• Waterproof, windproof and breathable membrane.</li> <li>• Water-resistant zippers at back and underarm vents.</li> <li>• Removable collar with neoprene replacement panel to accommodate neck brace.</li> <li>• Race-approved blaze orange.</li> </ul> <p><b>Mesh inner lining.</b></p> <ul style="list-style-type: none"> <li>• Underarm and back venting.</li> <li>• Front offset opening with flap.</li> <li>• Oversized front pocket.</li> <li>• Articulated shoulders and shaped sleeves.</li> <li>• Adjustable collar, hem and wrists.</li> <li>• Reflective detailing.</li> </ul>	<ul style="list-style-type: none"> <li>• Easy to get into and out of, even with helmet or safety vest on.</li> <li>• Keeps you dry and warm all day.</li> <li>• Racing-specific features, such as added visibility.</li> <li>• Becomes more breathable the harder you ride for comfort.</li> <li>• Enables you to match warmth to conditions and riding style.</li> <li>• Customizable fit.</li> </ul>		<p>XS, S, M, L, XL, 2XL, 3XL</p>	<p>\$379.99</p>
<p><b>SNO-X RACE EDITION</b> PANTS 441571</p>	 <p><b>P. 32</b></p>	<p><b>SHELL</b> Sympatex 2-Ply Laminated Polyester</p>  	<ul style="list-style-type: none"> <li>• Waterproof, windproof and breathable membrane.</li> <li>• 100% seams and logos sealed.</li> <li>• Hip pockets and thigh venting with water-resistant zippers.</li> <li>• Articulated, shaped knees and knee padding.</li> </ul> <p><b>Reinforced inner leg and crotch.</b></p> <ul style="list-style-type: none"> <li>• Mesh lining.</li> <li>• Full-length water-resistant side zippers.</li> <li>• Adjustable waist.</li> <li>• Removable suspenders.</li> </ul>	<ul style="list-style-type: none"> <li>• Keeps you dry and warm all day.</li> <li>• Become more breathable the harder you ride, for comfort.</li> <li>• Racing-specific features, such as protection.</li> <li>• Easy to get into and out of.</li> </ul>		<p>XS, S, M, L, XL, 2XL, 3XL</p>	<p>\$349.99</p>





**X-TEAM WINTER JACKET**  
Insulation and features for performance trail riding with race team style.  
Shell: 60% Polyester, 40% Nylon  
Insulation: PrimaLoft Black  
440720 • XS, S, M, MT, L, XL, XLT, 2XL  
Grey (09), Red (30), Black (90), Sunburst Yellow (96)  
**\$319.99**

Tall sizes  
Shell: 60% Polyester, 40% Nylon  
442428 • 2XLT, 3XL, 3XLT, 4XL  
Black (90), Sunburst Yellow (96)  
442432 • 5XL  
Black (90)  
**\$339.99**



**NEW**  
**SKI-DOO WARNERT MAKITA® RACE EDITION JACKET**  
Straight from the race track with insulation and features for performance trail riding.  
Shell: 60% Polyester, 40% Nylon  
Insulation: PrimaLoft Black  
440728 • S, M, L, XL, 2XL  
Sunburst Yellow (96)  
**\$369.99**



**X-TEAM WINTER HIGHPANTS**  
Designed for performance trail riding with full insulation and style.  
Shell: 99% Polyester, 1% Nylon  
Insulation: PrimaLoft Black  
441573 • XS, S, M, L, XL, 2XL  
Black (90)  
**\$279.99**  
Tall sizes  
441577 • MT, LT, XLT, 2XLT, 3XL, 3XLT, 4XL, 4XLT, 5XL  
Black (90)  
**\$289.99**



**X-TEAM JACKET**  
Women's fit, style and colors in an insulated performance jacket with race team style.  
Shell: 70% Polyester, 30% Nylon  
Insulation: PrimaLoft Black  
440721 • XS, S, M, L, XL, 2XL, 3XL  
Grey (09), Pink (36), Black (90)  
**\$309.99**



**X-TEAM HIGHPANTS**  
Cold temperature performance highpants with a feminine cut.  
Shell: 99% Polyester, 1% Nylon  
Insulation: PrimaLoft Black  
441574 • XS, S, M, L, XL, 2XL, 3XL  
Black (90)  
**\$249.99**





# SKI-DOO BACKCOUNTRY EXPERT PROFILE TONY JENKINS

## CURRENT SLED

Summit X 163 with 3 in. track

## PASSION

Anything that has to do with being in the outdoors... camping, dirt biking, fishing, hunting, mountain biking. I also love spending a lot of time with my wife and children. My family and friends will tell you I'm always finding adventures and never getting home before dark.

Riding snowmobiles has driven me to keep pushing the sport and to share my passion for riding. From teaching backcountry clinics to weekend adventures with friends, I have always had a passion to ride. I'm fortunate enough to live in Southeast Idaho, where in a good snow year I'll ride from November to June. Riding 8 months out of the year only leaves me 4 months to prepare for the next season – you know how that is.

## RIDING

My favorite area is in Southeast Idaho, mainly because I know the areas so well and we always have good snow coverage being so close to the continental divide. Even on a bad snow year I will head for the North-facing slopes that are filled with trees and go exploring. I've been fortunate enough to ride a lot of different and unique areas in North America from Washington, Oregon, Montana, Wyoming, Utah, Colorado to British Columbia and have found that being on the Idaho/Wyoming border offers some of the best riding around – especially if you like technical riding like I do.



The more you perspire the more breathable the Sno-X Race Edition Shell and Pants get, thanks to the Sympatex windproof, waterproof and breathable membrane.



### SNO-X RACE EDITION PANTS

Lightweight non-insulated pants.

Shell: Sympatex 2-Ply Laminated Polyester

441571

XS, S, M, L, XL, 2XL, 3XL  
Orange (12)

**\$349.99**



### WARM-UP COAT

The ultimate racer's overcoat is here for all racers and fans. Stay warm at the races and show your colors.

Shell: 95% Polyester, 5% Nylon  
Insulation: Thermal Loft

440703 • One size  
Sunburst Yellow (96)

**\$279.99**



### SNO-X RACE EDITION SHELL

Designed with professional racers.

Shell: Sympatex 2-Ply Laminated Polyester

440722 • XS, S, M, L, XL, 2XL, 3XL  
Orange (12)

**\$379.99**



FOLLOW TONY ON INSTAGRAM: @tony\_jenkins

## GEAR

I made the change to Ski-Doo riding gear this year. I ride both the Helium 50 Jacket and Highpants. I have the Helium 50 because I'm extremely hard on gear and it has the tougher shell. The MCode Gloves are very good... but the Highmark Gloves are really something else. Just great feel and they stay so dry. Great fit, too.

## NORMAL JOB

Well... this is hard one for me to answer! It's not a "normal job." What I can tell you is that it involves a lot of fun and challenging training, and I have the flexibility to ride my Ski-Doo on my days off. But let's be real – I'd last about two days in a "normal job!"

## MOST FUN ON A SLED EVER

When you're out riding with your buddy and you look down and you need your headlights to see where you're heading is a good day. I've had a couple encounters where I had dropped off some mountain top and found myself in the bottom of a canyon with running water and darkness and an empty fuel tank (Hey, I thought it was a short cut!). I ended up spending the night and getting out in the early morning (that's why I always take the right survival gear). For some reason, these are my most memorable rides! (The funny thing is my wife knows not to call search and rescue for at least 2 days because they will never find me and I would have to go rescue them after I got myself out – no joke!)



OUR TOURING GEAR. YOUR NEXT EPIC RIDE.

# TOURING

TECHNOLOGY AND SMART DESIGN FOR ALL-DAY COMFORT WITH MODERN STYLE.







## FEATURES

## BENEFITS

## PERFORMANCE RATINGS

## SIZES

## PRICE

<p><b>ABSOLUTE 0 JACKET</b> 440748 • 440698</p>	<p><b>P. 38</b></p>  <p>Men's Ladies'</p>	<p><b>SHELL</b> Sympatex 2-Ply Laminated Polyester</p> 	<ul style="list-style-type: none"> <li>• 100% seams and logos sealed.</li> <li>• Waterproof, windproof and breathable membrane.</li> <li>• Underarm venting.</li> <li>• Removable liner and hood.</li> <li>• Center front quadruple flaps with 2 offset zippers.</li> <li>• Removable and adjustable synthetic down collar to seal air entry.</li> <li>• Shaped sleeves.</li> <li>• Powder skirt.</li> <li>• Action back pleat.</li> <li>• Reflective detailing.</li> <li>• Water-resistant zippers at front opening, pockets and vents.</li> </ul>	<ul style="list-style-type: none"> <li>• Keeps you dry and warm all day, but not bulky.</li> <li>• Lightweight and flexible for comfort.</li> <li>• Many features to match warmth to conditions and riding style.</li> <li>• Seals out wind and elements.</li> </ul>		<p>Men's S, M, L, XL, 2XL, 3XL</p> <p>Ladies' XS, S, M, L, XL, 2XL, 3XL</p>	<p>Men's <b>\$499.99</b></p> <p>Ladies' <b>\$499.99</b></p>
<p><b>ABSOLUTE 0 HIGHPANTS</b> 441494 • 441495</p>	<p><b>P. 38</b></p>  <p>Men's Ladies'</p>	<p><b>SHELL</b> Sympatex 2-Ply Laminated Polyester</p> 	<ul style="list-style-type: none"> <li>• 100% seams and logos sealed.</li> <li>• Waterproof, windproof and breathable membrane.</li> <li>• Full-length 2-way water-resistant side zippers with double flaps.</li> <li>• Polar fleece-lined seat.</li> <li>• Shaped, padded and reinforced knees and adjustable waist.</li> <li>• Reinforced crotch and seat.</li> <li>• Storm gaiters.</li> </ul>	<ul style="list-style-type: none"> <li>• Keeps you dry and warm all day, but not bulky.</li> <li>• Lightweight and flexible for comfort.</li> <li>• Added insulation at point of contact with sled for extra warmth.</li> <li>• Easy to get into and out of.</li> </ul>		<p>Men's XS, S, M, L, XL, 2XL, 3XL</p> <p>Ladies' XS, S, M, L, XL, 2XL, 3XL</p>	<p>Men's <b>\$399.99</b></p> <p>Ladies' <b>\$399.99</b></p>
<p><b>ABSOLUTE TRAIL JACKET</b> 440702</p>	<p><b>P. 39</b></p> 	<p><b>SHELL</b> Sympatex 2-Ply Laminated Polyester</p> 	<ul style="list-style-type: none"> <li>• 100% seams and logos sealed.</li> <li>• Waterproof, windproof and breathable membrane.</li> <li>• Underarm and back venting.</li> <li>• Powder skirt.</li> <li>• Shaped sleeves and triple front flaps with microfleece polyester.</li> </ul>	<ul style="list-style-type: none"> <li>• Keeps you dry and warm all day.</li> <li>• Becomes more breathable the harder you ride, for comfort.</li> <li>• Seals out wind and elements.</li> <li>• Enable you to match warmth to conditions and riding style.</li> <li>• Good coverage and comfort while riding all day.</li> </ul>		<p>S, M, L, XL, 2XL, 3XL</p>	<p><b>\$429.99</b></p>
<p><b>ABSOLUTE TRAIL HIGHPANTS</b> 441570</p>	<p><b>P. 39</b></p> 	<p><b>SHELL</b> Sympatex 2-Ply Laminated Polyester</p> 	<ul style="list-style-type: none"> <li>• 100% seams and logos sealed.</li> <li>• Waterproof, windproof and breathable membrane.</li> <li>• Full-length side zippers.</li> <li>• Shaped and padded knees for protection and adjustable waist and removable suspenders.</li> <li>• Storm gaiters.</li> <li>• Hip pockets.</li> <li>• Cordura insert at knees.</li> </ul>	<ul style="list-style-type: none"> <li>• Keeps you dry and warm all day.</li> <li>• Become more breathable the harder you ride, for comfort.</li> <li>• Seal out wind and elements.</li> <li>• Enable you to match warmth to conditions and riding style.</li> </ul>		<p>S, M, L, XL, 2XL, 3XL</p>	<p><b>\$389.99</b></p>

			FEATURES	BENEFITS	PERFORMANCE RATINGS	SIZES	PRICE	
HEATED VEST LINER 440645	 P. 40		<ul style="list-style-type: none"> <li>Insulated, stretchable and water-resistant shell.</li> <li>Durable wind-blocking layer.</li> <li>Xtreme Comfort Technology: hair-thin, micro alloy fibers and modules.</li> <li>Two flexible heating panels at chest and two at lower back.</li> <li>Built-in control panel at chest.</li> <li>IC protection and UL certification.</li> <li>Rechargeable lithium battery, up to 5 hours of heating time.</li> <li>Easy access battery pocket.</li> <li>1 wall charger included and vehicle charger sold separately (4880600090).</li> </ul>	<ul style="list-style-type: none"> <li>Electronic heating modules keep you warm and enable you to easily adjust the temperature.</li> <li>Provides extra warmth by blocking wind.</li> <li>Safe and sophisticated.</li> <li>Runs on rechargeable battery for up to 5 hours.</li> </ul>		XS, S, M, L, XL, 2XL, 3XL	\$159.99	
GLIDE LED JACKET 440605	 P. 40	<p>SHELL 100% Nylon</p> 	<ul style="list-style-type: none"> <li>100% seams and logos sealed.</li> <li>Underarm and back venting.</li> <li>LED lighting, requires 2 AA batteries. (not included)</li> <li>Removable insulated lining.</li> <li>Shaped sleeves and stretch fabric at elbows and adjustable collar, waist and wrists.</li> </ul>	<ul style="list-style-type: none"> <li>Handwarmer pockets.</li> <li>Double front flaps.</li> <li>Articulated shoulders.</li> <li>Includes removable battery pack.</li> </ul>	<ul style="list-style-type: none"> <li>Great performance with LED lighting for visibility at night or in snow dust.</li> <li>Enables you to match warmth to conditions and riding style.</li> <li>Good coverage and comfort while riding all day.</li> <li>Customizable fit.</li> </ul>		XS, S, M, L, XL, 2XL	\$399.99
GLIDE JACKET 440661	 P. 40	<p>SHELL 100% Nylon</p> 	<ul style="list-style-type: none"> <li>100% seams and logos sealed.</li> <li>Underarm and back venting.</li> <li>Removable insulated lining.</li> <li>Double front flaps.</li> <li>Adjustable collar, waist and wrists.</li> <li>Articulated shoulders, shaped sleeves and stretch fabric at elbows.</li> <li>Handwarmer pockets.</li> </ul>	<ul style="list-style-type: none"> <li>Keeps you dry and warm all day.</li> <li>Enables you to match warmth to conditions and riding style.</li> <li>Good coverage and comfort while riding all day.</li> <li>Customizable fit.</li> </ul>		XS, S, M, L, XL, 2XL, 3XL	\$339.99	
VOYAGER HIGHPANTS 441554 • 441478	 P. 40-41 Men's Ladies'	<p>SHELL Men's: 80% Nylon, 20% Polyester Ladies': Nylon</p> 	<ul style="list-style-type: none"> <li>100% seams and logos sealed.</li> <li>Waterproof, windproof and breathable.</li> <li>Polar fleece-lined seat and knees.</li> <li>Storm gaiters.</li> <li>Shaped knees.</li> <li>Adjustable waist.</li> <li>2-way full-length side zippers.</li> </ul>	<p>Men's</p> <ul style="list-style-type: none"> <li>1000 denier nylon-lined seat, knees and inner legs and padded knees.</li> <li>Composite insulation construction.</li> </ul> <p>Ladies'</p> <ul style="list-style-type: none"> <li>Adjustable waist, stretch fleece bib and drop seat design.</li> </ul>	<ul style="list-style-type: none"> <li>Keeps you dry and warm all day.</li> <li>Lightweight and flexible for comfort.</li> <li>Added insulation at point of contact with sled for extra warmth.</li> <li>Seal out wind and elements.</li> <li>Easy to get into and out of.</li> </ul>		<p>Men's XS, S, M, MT, L, LT, XL, XLT, 2XL</p> <p>Ladies' XS, S, M, MT, L, LT, XL, XLT, 2XL, 3XL</p>	<p>Men's \$269.99</p> <p>Ladies' \$269.99</p>
MUSKOKA JACKET 440704	 P. 41	<p>SHELL 100% Polyester</p> 	<ul style="list-style-type: none"> <li>100% seams and logos sealed.</li> <li>Waterproof, windproof and breathable.</li> <li>Powder skirt.</li> <li>Handwarmer pockets.</li> <li>Underarm venting.</li> <li>Removable synthetic fur around detachable insulated hood.</li> </ul>	<ul style="list-style-type: none"> <li>Adjustable collar, hem and wrists.</li> <li>Front flap and additional inner flap.</li> <li>Inner fleece cuffs.</li> <li>Reflective detailing.</li> </ul>	<ul style="list-style-type: none"> <li>Women's cut and fit for comfort and flair.</li> <li>Keeps you dry and warm all day.</li> <li>Enables you to match warmth to conditions and riding style.</li> </ul>		XS, S, M, L, XL, 2XL, 3XL	\$279.99



Sympatex membrane is 100% recyclable like a PET bottle Sympatex is Oeko-Tex' standard 100, guaranteeing the membrane causes no harm to health Sympatex contains no PTFE or PFC to be environmentally friendly.

**DID YOU KNOW** The fibers in the PrimaLoft Gold insulation used in Absolute 0 gear are modeled after actual goose down fibers.



**ABSOLUTE 0 JACKET**

You'll have a hard time finding a warmer jacket in any sport. Tailormade for extreme temperatures and conditions.

**Shell:** Sympatex 2-Ply Laminated Polyester  
**Insulation:** PrimaLoft Gold

440748 • S, M, L, XL, 2XL, 3XL  
Black (90)

**\$499.99**



**ABSOLUTE 0 HIGHPANTS**

The best materials and designs are used to make the warmest pants we've ever offered. Totally windproof, waterproof and breathable.

**Shell:** Sympatex 2-Ply Laminated Polyester  
**Insulation:** PrimaLoft Gold

441494 • XS, S, M, L, XL, 2XL, 3XL  
Black (90)

**\$399.99**



**LADIES' ABSOLUTE 0 JACKET**

Our warmest women's jacket ever. Built with the best materials on the market, including Sympatex and PrimaLoft for maximum comfort.

**Shell:** Sympatex 2-Ply Laminated Polyester  
**Insulation:** PrimaLoft Gold

440698 • XS, S, M, L, XL, 2XL, 3XL  
Black (90)

**\$499.99**



**LADIES' ABSOLUTE 0 HIGHPANTS**

The best materials and practices are used in these no-compromise pants. Highly windproof, waterproof and breathable. Protect against the elements for maximum performance in all conditions.

**Shell:** Sympatex 2-Ply Laminated Polyester  
**Insulation:** PrimaLoft Gold

441495 • XS, S, M, L, XL, 2XL, 3XL  
Black (90)

**\$399.99**



**ABSOLUTE TRAIL JACKET**

Sharp styling, leading technology combined in a high performance jacket for active to moderate riders.

**Shell:** Sympatex 2-Ply Laminated Polyester  
**Insulation:** PrimaLoft Black

440702 • S, M, L, XL, 2XL, 3XL  
Orange (12), Black (90)

**\$429.99**



Sympatex is the modern membrane for moisture control.



**ABSOLUTE TRAIL HIGHPANTS**

The complementary pants to our advanced technology Absolute Trail Jacket.

**Shell:** Sympatex 2-Ply Laminated Polyester  
**Insulation:** PrimaLoft Black

441570 • S, M, L, XL, 2XL, 3XL  
Black (90)

**\$389.99**





4 3 3

**GLIDE JACKET**

Classic lines and refined cut deliver great fit and style on the trails. Removable liner helps keep you comfortable in all conditions.

Shell: 100% Nylon  
Insulation: PrimaLoft Silver

440661  
XS, S, M, L, XL, 2XL, 3XL  
Yellow (10),  
Orange (12), Black (90)

**\$339.99**



5 2 2

**HEATED VEST LINER**

The ultimate in riding warmth and temperature regulation, as you control this vest's electronic heating modules.

440645  
XS, S, M, L, XL, 2XL, 3XL  
Black (90)

**\$159.99**



**LITHIUM-ION BATTERY**

(Not illustrated)  
4880590001

**\$39.99**

**LITHIUM-ION BATTERY VEHICLE CHARGER**

(Not illustrated)  
• Allows to recharge the Heated Vest Liner while riding.

4880600090

**\$29.99**

4 3 3

**GLIDE LED JACKET**

Unmatched visibility with LED lighting integrated into our full-featured Glide Jacket.

Shell: 100% Nylon  
Insulation: PrimaLoft Silver

440605  
XS, S, M, L, XL, 2XL  
Black (90)

**\$399.99**



4 3 3

**VOYAGER HIGHPANTS**

One of our warmest and full-featured trail-riding pants.

Shell: 80% Nylon, 20% Polyester  
Insulation: PrimaLoft Silver

441554  
XS, S, M, MT, L, LT, XL, XLT, 2XL  
Black (90)

**\$269.99**



4 3 3

**MUSKOKA JACKET**

A classy, high style look for the ladies out on the trails.

Shell: 100% Polyester  
Insulation: PrimaLoft Silver

440704 • XS, S, M, L, XL, 2XL, 3XL  
Violet (41), Teal (74), Black (90)

**\$279.99**

4 3 3

**VOYAGER HIGHPANTS**

Women's fit and all the features you'd expect in one of our warmest pants.

Shell: Nylon  
Insulation: PrimaLoft Silver

441478 • XS, S, M, MT, L, LT, XL, XLT, 2XL, 3XL  
Black (90)

**\$269.99**



**FEEL THE PERFORMANCE  
WITH PRIMALOFT® INSULATION.  
IT'S MORE THAN A JACKET**

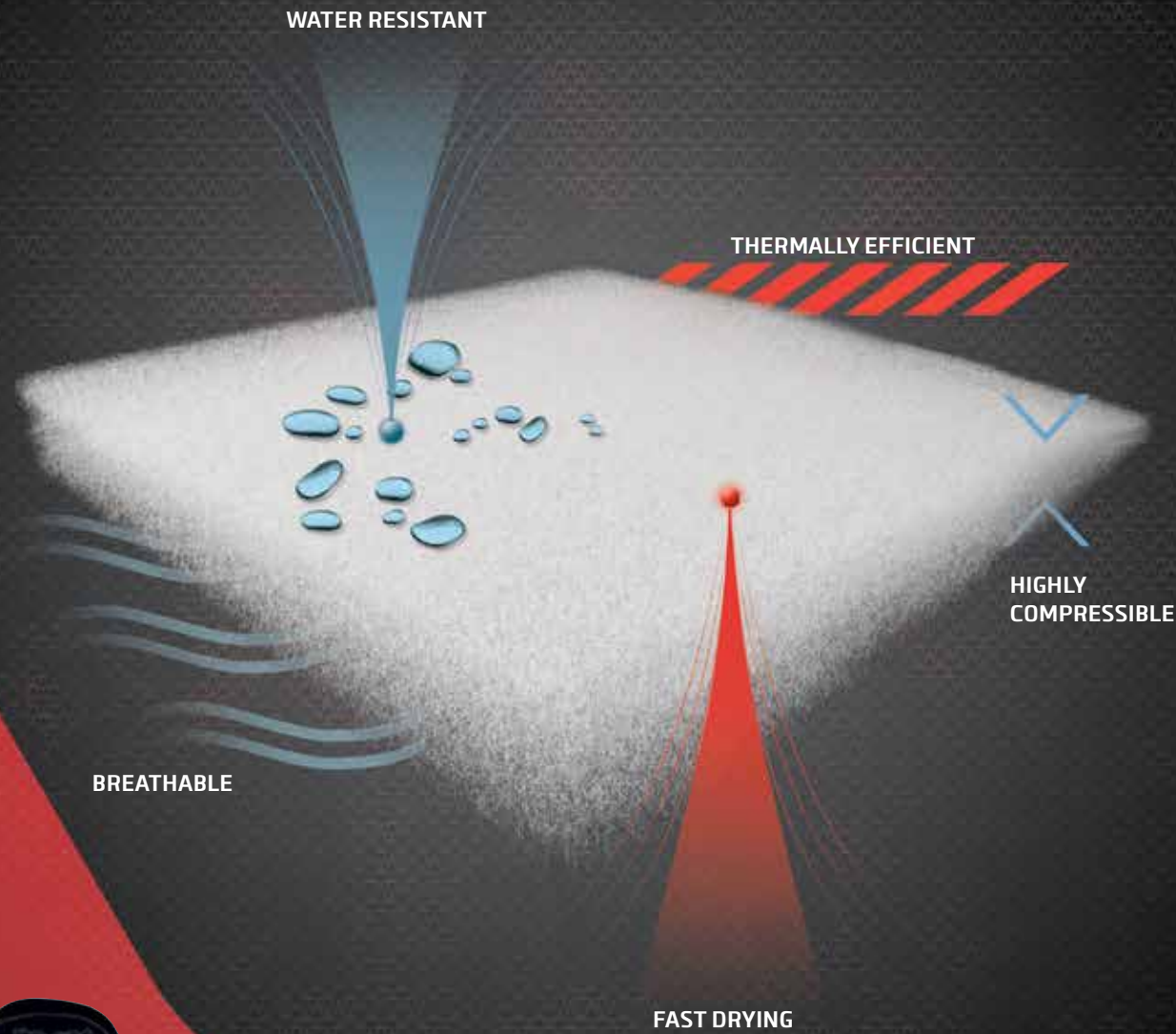

The Absolute 0 Jacket features superior PrimaLoft® insulation, delivering ultimate warmth and comfort without bulk - even when wet. With a high warmth-to-weight ratio, exceptional water-resistance and breathability, you'll stay warm, dry and comfortable in the harshest weather.

REDISCOVER COMFORT AT THE NEW PRIMALOFT.COM

PrimaLoft® is a registered trademark of PrimaLoft, Inc. ©2016 PrimaLoft, Inc.

## SKI-DOO SLEDS AND RIDING GEAR CORNERSTONE OF RIDING EXPERIENCE

Thomas and his crew take out riders of many different ages and experience levels. And he has Ski-Doo gear to help keep them all comfortable and safe.



Thomas and Seema

Thomas Wårdell and his fiancée Seema Edström have turned their passion for the outdoors and snowmobiling into a career. A world-class snowmobiler who has been in many European sled films, Wårdell started Terrain Events Thomas Wårdell Riding Experience to teach snowmobile riding technique, technology, proper clothing and safety to individuals and companies, especially skiers and snowboarders. Snowmobilers in Sweden must have a sled driver's license, and Thomas and his team offer programs enabling guests to earn one.

"Making a good impression and ensuring our guests have a fun, first-class experience are critical to the success of our business," says Wårdell. "That's why we choose Ski-Doo snowmobiles and accessories. The ability to customize the sleds and easily add and remove accessories makes our jobs easier and our guests have more fun."



Wårdell, his guiding/instructor crew and one of the Summit Burton sleds from their fleet. Many guests mix skiing and snowboarding with their sledding classes, so the Summit Burton sled is ideal.

A LinQ Premium Tunnel BAG packed with essentials for backcountry riding.

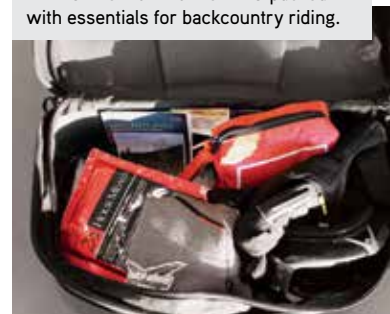

The Adjustable Handlebar Riser allows for machines to be fitted for different size riders quickly and effectively.

It's important to bring along the right gear. The Wårdell crew uses LinQ bags, OGIO backpacks and Summit seat bags.



Thomas teaching proper sidehill technique on his Summit Burton.



Wårdell's organization uses Superclamps, available from BRP dealers, to secure their sleds when trailering between riding areas.

OUR RECREATIONAL / UTILITY GEAR. YOUR NEXT JOB WELL DONE.

# RECREATIONAL / UTILITY

WORK OR PLAY HARD – AT A GREAT VALUE – WITH GEAR FEATURING FUNCTIONAL DESIGNS FROM OUR UNMATCHED EXPERIENCE IN SNOWMOBILING.

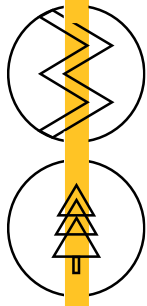

## HOLESHOT JACKET

For decades, our Holeshot Jacket has bundled more affordable value than any other jacket on the market.

- All critical seams sealed.
- Shaped sleeves and adjustable hem and wrists.
- Handwarmer pockets.
- Added reflective detailing for optimal visibility.

Shell: Orange/Sunburst Yellow: 73% Nylon, 27% Polyester. Black: 100% Nylon  
Insulation: Thermal Loft

440701 • XS, S, M, MT, L, LT, XL, XLT, 2XL  
Orange (12), Black (90), Sunburst Yellow (96)

\$189.99



## TRAIL HIGHPANTS

Classic look for anytime winter wear warmth.

- All critical seams sealed.
- Waterproof 1000 denier nylon at seat and knees.
- Articulated knees.
- Storm gaiters.
- 2-way full-length side zippers.

Shell: Nylon  
Insulation: Thermal Loft

<b>Men's</b> 441584 XS, S, M, MT, L, LT, XL, XLT, 2XL Black (90)	<b>Ladies'</b> 441583 XS, S, M, L, XL, 2XL, 3XL Black (90)
--	--

\$179.99      \$179.99



## TRACK & TRAIL JACKET

A perfect all around jacket that is packed with technical features at an affordable price.

- All critical seams sealed.
- Shaped sleeves.
- Handwarmer pockets.
- Adjustable collar, hem and wrists.

Shell: Polyester  
Insulation: Thermal Loft

\$199.99



Men's 440619 • S, M, MT, L, LT, XL, XLT, 2XL  
Yellow (10), Orange (12)

Ladies' 440620 • XS, S, M, L, XL  
White (01), Yellow (10)

**DID YOU KNOW** RPM technology was developed by BRP to provide excellent waterproofness and breathability.



## EXPEDITION JACKET

A full-featured jacket that's ready to work - or play - as hard as you do. Parka length for warmth with 9 pockets and reflective webbing.

- Parka length.
- Side slits.
- Teflon HT coating.
- Two insulated front zipper flaps.
- Powder skirt.
- Detachable hood.
- Reinforced elbows and forearms.
- Easy-to-reach bicep vents.
- Adjustable collar and wrists.
- Microfleece inner neck and sleeve cuffs.
- All critical seams sealed.

Shell: 95% Nylon, 5% Polyester  
Insulation: PrimaLoft Black

440718 • XS, S, M, L, XL, 2XL, 3XL  
Black (90)

\$249.99



## EXPEDITION HIGHPANTS

Ready to work and play with features delivering durability, safety and warmth.

- Teflon HT coating repels dirt.
- Reinforcements at seat and inside knees, legs and hems.
- Fleece-lined seat.
- Full-length side zippers.
- 2 large cargo pockets.
- Adjustable suspenders.
- Storm gaiters.
- Wide reflective webbing.

Shell: 90% Nylon, 10% Polyester  
Insulation: PrimaLoft Black

441594 • XS, S, M, L, XL, 2XL, 3XL  
Black (90)

\$249.99



# TECHNICAL WEAR

STAYING WARM MEANS STAYING DRY. MATCH YOUR COMFORT TO YOUR RIDING STYLE WITH OUR SNOWMOBILE-SPECIFIC TECHNICAL BASE AND MID LAYERS.

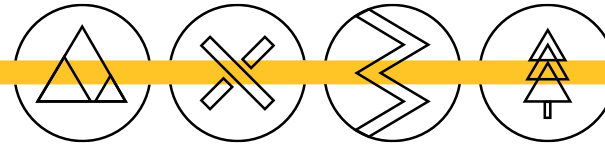

## HOW IT WORKS

Each layer has a function. You get the best performance and versatility when you dress in a system with base layer, mid layer and outer layer.

### OUTER LAYER

Keeps wind and water out and breathes. Adds insulation for warmth.

### MID LAYER

Dials in your warmth level. Add or remove during the day as conditions change.

### BASE LAYER

Close to the body to wick perspiration and prevent chills. Adds warmth. Avoid cotton — it gets wet and stays wet.

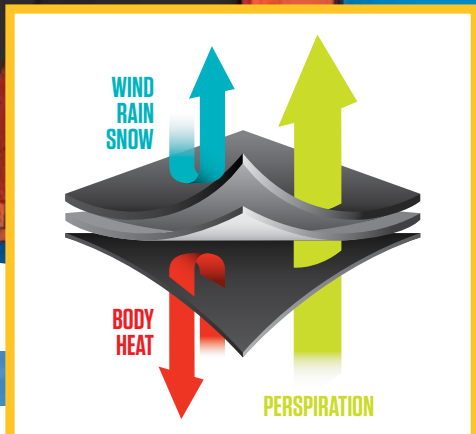

## CREATE YOUR OWN CLIMATE

The combination of base layer, mid layer and outer layer works together to keep you warm and comfortable. Select and combine each to create your own climate for how you ride. For instance:



### ACTIVE MOUNTAIN RIDER

Needs highly breathable gear to let perspiration escape.

### ACTIVE TRAIL RIDER

Needs breathability with a bit more insulation, especially in colder climates.

### LONG DISTANCE CRUISER

Needs more thermal gear with added insulation.

We've made it easy to choose just the right gear. Look for these ratings with each layer. You can even add the warmth ratings of different layers together for an overall system rating. Learn more about our climate rating system on pages 8-9.

- WARMTH
- WATERPROOF / WINDPROOF
- BREATHABILITY



BASE LAYERS



1 1 5

**ULTRALIGHT BASE LAYER**

- Coconut fibers actively promote evaporative cooling and odor absorption, and to filter moisture out while trapping warmth in.
- Mesh paneled in specific areas for better ventilation and accelerated drying.
- Spandex for ease of movement.

**Top**  
453544 • S, M, L, XL, 2XL, 3XL  
Charcoal Grey (07)  
**\$44.99**

**Bottom**  
453545 • S, M, L, XL, 2XL, 3XL  
Charcoal Grey (07)  
**\$34.99**



1 1 5

**ACTIVE BASE LAYER**

- X-STATIC<sup>®</sup> enhanced through to the fiber to thermodynamically regulate your temperature by reflecting body heat back to the skin in cold weather.
- Permanently treated for long-lasting antibacterial performance even after 250 washes.
- Silver woven into fiber immediately binds with odor-causing agents such as ammonia and denatured proteins to instantly reduce odor.
- Panels in specific areas for better ventilation and accelerated drying.
- Compressed for added comfort.

**Top**  
453554 • S, M, L, XL, 2XL, 3XL  
Black (90)  
**\$59.99**

**Bottom**  
453555 • S, M, L, XL, 2XL, 3XL  
Black (90)  
**\$54.99**

92% Polyester, 6% Spandex, 2% X-STATIC



2 1 4

**THERMAL PANTS**

- Made of high-filament polyester enhanced by slight brushing to provide softness and warmth.
- Spandex for ease of movement.

95% Polyester, 5% Spandex

453592 • XS, S, M, L, XL, 2XL  
Charcoal Grey (07)

**\$59.99**



2 1 4

**THERMAL BASE LAYER**

- Made of high-filament polyester enhanced by slight brushing to provide softness and warmth.
- Spandex for ease of movement.

95% Polyester, 5% Spandex

**Top**  
453569 • S, M, L, XL, 2XL, 3XL  
Charcoal Grey (07), Yellow (10), Red (30)  
**\$64.99**

**Bottom**  
453553 • S, M, L, XL, 2XL, 3XL  
Charcoal Grey (07)  
**\$49.99**

MID LAYERS

NEW 4 4 3

**TECH WINDPROOF FLEECE JACKET**

High tech windproof and water-resistant jacket can be used as a mid layer or cool weather light jacket.

- Textured polyester fleece shell.
- Windproof, water-resistant membrane.
- Zippered, contoured pockets.
- Embroidered logo.

453816 • S, M, L, XL, 2XL  
Black (90)

**\$119.99**



2 2 4

**TECH MID LAYER FLEECE**

- Textured polyester fleece with brushed interior for softness.
- Zippered pocket.
- Reflective silver accents for visibility.
- Shaped sleeves.
- Placket behind collar zipper prevents wind intrusion.

100% Polyester

453799 • XS, S, M, L, XL, 2XL  
Black (90)

**\$99.99**



2 1 4

**COZY FLEECE JACKET**

A semi-fitted fleece jacket for use under a riding jacket or for relaxing around the house.

- Technical moisture-wicking stretch fabric.
- Antibacterial to reduce odors.
- Zip mesh pocket.
- Semi-fitted.
- Ski-Doo logo at front.

95% Polyester, 5% Spandex

453791 • S, M, L, XL, 2XL, 3XL  
Black (90)

**\$74.99**



3 2 4

**ARCTIC FLEECE**

- Mid layer thermal fleece with slight brushing for more comfort.
- Moisture-wicking fabric.
- Antibacterial and anti-pilling.
- Handwarmer pockets.

95% Polyester, 5% Spandex

453676 • S, M, L, XL, 2XL, 3XL  
Black (90)

**\$99.99**



2 1 4

**MCODE MID LAYER**

Great mid layer choice with MCode attitude.

- Mid layer thermal fleece.
- Brushed interior for softness and non-pilling.
- Moisture-wicking.
- Antibacterial to reduce odors.
- Handwarmer pockets.

95% Polyester, 5% Spandex

453777 • S, M, L, XL, 2XL, 3XL  
Green (70), Blue (80)  
**\$99.99**



3 2 4

**SKI-DOO ZIP UP MID LAYER**

- Moisture wicking.

100% Polyester Mesh

453766 • S, M, L, XL, 2XL, 3XL  
Charcoal Grey (07), Black (90)

**\$89.99**



3 2 4

**SNO-X FLEECE**

- Full zip with 2 front hip pockets.
- X-Team embroidered logo.
- Bonded fleece heavy mid layer.

100% Polyester

453769 • XS, S, M, L, XL, 2XL, 3XL  
Orange (12), Black (90)

**\$89.99**



2 1 4

**X-TEAM MICROFLEECE**

- Zippered handwarmer pockets.
- Welded pocket outline.
- X-Team embroidered logo on sleeve.

100% Polyester

453762 • S, M, L, XL, 2XL, 3XL  
Grey (09), Black (90)

**\$69.99**

CREATE YOUR CLIMATE WITH THE BRP PERFORMANCE RATINGS P.8-9

USE THE TUNNEL BACKPACK WITH LinQ SOFT STRAP TO BRING AN EXTRA LAYER DURING LONG RIDES P.135



WATCH HOW TO STAY WARM IN ALL CONDITIONS BY LAYERING WITH TECHNICAL CLOTHING. GO TO: [WWW.SKI-DOO.COM/GENUINE-PARTS-ACCESSORIES-RIDING-GEAR/CATALOG-VIDEO](http://WWW.SKI-DOO.COM/GENUINE-PARTS-ACCESSORIES-RIDING-GEAR/CATALOG-VIDEO)

BASE LAYERS



1 1 5

**ULTRALIGHT BASE LAYER**

- Coconut fibers actively promote evaporative cooling and odor absorption, and to filter moisture out while trapping warmth in.
- Mesh paneled in specific areas for better ventilation and accelerated drying.
- Spandexed for ease of movement.

**Top**  
453546 • XS, S, M, L, XL, 2XL  
Charcoal Grey (07)

**\$44.99**

**Bottom**  
453547 • XS, S, M, L, XL, 2XL  
Charcoal Grey (07)

**\$34.99**



1 1 5

**ACTIVE BASE LAYER**

- X-STATIC enhanced through to the fiber to thermodynamically regulate your temperature by reflecting body heat back to the skin in cold weather.
- Permanently treated for long-lasting antibacterial performance even after 250 washes.
- Silver woven into fiber immediately binds with odor-causing agents such as ammonia and denatured proteins to instantly reduce odor.
- Panels in specific areas for better ventilation and accelerated drying.
- Compressed for added comfort.

**Top**  
453548 • XS, S, M, L, XL, 2XL  
Black (90)

**\$59.99**

**Bottom**  
453549 • XS, S, M, L, XL, 2XL  
Black (90)

**\$54.99**

92% Polyester, 6% Spandex, 2% X-STATIC

2 1 4

**THERMAL BASE LAYER**

- Made of high-filament polyester enhanced by slight brushing to provide softness and warmth.
- Spandexed for ease of movement.

**Top**  
453568 • XS, S, M, L, XL, 2XL  
White (01), Charcoal Grey (07)

**\$64.99**

**Bottom**  
453551 • XS, S, M, L, XL, 2XL  
Charcoal Grey (07)

**\$49.99**



MID LAYERS

2 2 4

**TECH MID LAYER FLEECE**

- Women's cut with shaped sleeves.
- Textured polyester fleece with brushed interior for softness.
- Rhinestone and embroidered accents.
- Zippered pocket.
- Reflective silver accents for visibility.
- Placket behind collar zipper to keep cold out.

100% Polyester  
453800 • XS, S, M, L, XL, 2XL, 3XL  
Black (90)  
**\$99.99**



3 2 4

**MUSKOKA FLEECE**

- Full zip with 2 front hip pockets.
- Ski-Doo rubberized logo.
- Bonded fleece heavy mid layer.

100% Polyester  
453773 • XS, S, M, L, XL, 2XL  
Heather Grey (27)

**\$69.99**



2 1 4

**X-TEAM MICROFLEECE**

- Zippered handwarmer pockets.
- Outline X-Team embroidery on back.
- Embroidered Ski-Doo logo on left sleeve.

453768 • XS, S, M, L, XL, 2XL  
Grey (09), Pink (36), Black (90)  
**\$69.99**

2 1 4

**WEEKENDER ZIP UP SWEATER**

- Textured polyester fleece with brushed interior for softness.
- Handwarmer pockets.
- Ski-Doo logo on bottom.

100% Polyester  
453729 • XS, S, M, L, XL, 2XL  
Grey (09)  
**\$69.99**



2 1 4

**POLAR HOODIE**

- Fleece pullover hoodie.

100% Polyester  
453675 • XS, S, M, L, XL, 2XL  
Ice (38)  
**\$69.99**



3 2 4

**SUPREME FLEECE**

- Slim cut to flatter your figure.
- Stand-up collar helps keep neck cozy.
- Zippered handwarmer pockets and one zip-pocket on left chest.

453631 • XS, S, M, L, XL, 2XL  
Ice (38), Raspberry (39), Black (90)  
**\$69.99**



# INNOVATION LIKE NO OTHER

IT'S ABOUT MORE THAN COLORS AND GRAPHICS - IT'S ABOUT INNOVATIVE, SNOWMOBILE SPECIFIC FEATURES THAT PROVIDE GREAT VISION, WARMTH AND PROTECTION TO MAKE YOUR DAY MORE ENJOYABLE.

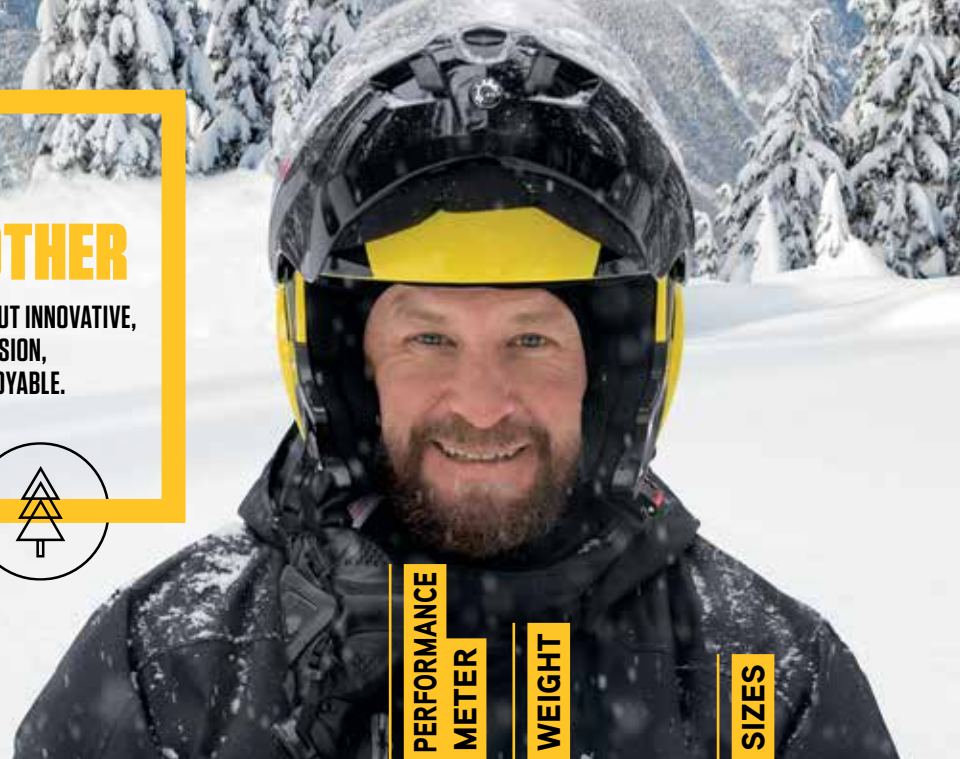
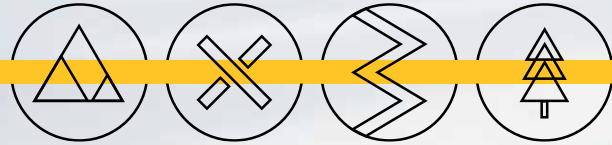

Learn everything about the Ski-Doo Helmets in action. Go to: [www.ski-doo.com/videos/gallery](http://www.ski-doo.com/videos/gallery)



## PERFORMANCE METER

## WEIGHT

## SIZES

## FEATURES

## BENEFITS

## PRICE

BV <sub>2</sub> S	 BV <sub>2</sub> S 447404	 BV <sub>2</sub> S Electric SE 447468	P. 56 SHELL Polycarbonate Composite			S, M, L, XL, 2XL, 3XL	<ul style="list-style-type: none"> <li>• Dual lens visor featuring Clear Vision Technology.</li> <li>• Lever activated sunshield.</li> <li>• Front push-buttons release for jaw piece.</li> <li>• BV<sub>2</sub>S fog-resistant mask system with soft surgical rubber seal and easy adjust knob.</li> <li>• Removable and washable inner liner.</li> <li>• Integrated backlight (batteries included).</li> <li>• Quick-release chin strap.</li> <li>• D.O.T. certified.</li> <li>• Electric heated shield (electric model only).</li> </ul>	<ul style="list-style-type: none"> <li>▶ Delivers fog-free 180° peripheral vision.</li> <li>▶ Easy to adjust to light conditions.</li> <li>▶ Easy operation with gloves on.</li> <li>▶ Adapts to all faces.</li> <li>▶ Keeps helmet fresh.</li> <li>▶ Added visibility.</li> <li>▶ Easy to secure and release.</li> </ul>	BV <sub>2</sub> S \$449.99  BV <sub>2</sub> S Electric SE \$529.99			
MODULAR 3	 Modular 3 X-Team Swift 448403	 Ladies' Modular 3 Swift 448404	P. 57 SHELL Polycarbonate Composite			S, M, L, XL, 2XL, 3XL	<ul style="list-style-type: none"> <li>• Clear Vision Technology with optically-correct dual lens visor.</li> <li>• Adjustable sunshield lowers or raises at the touch of a button.</li> <li>• Front push-buttons release integrated into jaw section.</li> <li>• BREATH EVAC fog-resistant mask system with increased vent diameter.</li> <li>• Quick-release chin strap.</li> <li>• Graphics applied with ink transfer process.</li> <li>• D.O.T. certified.</li> <li>• Electric heated shield (electric model only).</li> </ul>	<ul style="list-style-type: none"> <li>▶ Distortion - and fog-free vision.</li> <li>▶ Easily adapts to conditions.</li> <li>▶ Allows easy movement when wearing gloves.</li> <li>▶ Controlled breathing airflow in and out of helmet.</li> <li>▶ Easy to secure and release.</li> <li>▶ High quality finish with increased scratch resistance.</li> </ul>	Modular 3 \$299.99  Modular 3 X-Team Swift \$339.99  Ladies' Modular 3 Swift \$339.99  Modular 3 Electric SE \$369.99			
										 Modular 3 447963	 Modular 3 Electric SE 447964	

			PERFORMANCE METER	WEIGHT	SIZES	FEATURES	BENEFITS	PRICE
XP-R2	<p>P. 58</p> <p>SHELL Carbon Fiber Composite</p>  <p>XP-R2 Carbon Light Original 447826    XP-R2 Carbon Light Blaze 447657    XP-R2 Carbon Light Original 447656</p>		<p>Light</p> <p>Very light</p> <p>Ultra light</p>	XS, S, M, L, XL, 2XL, 3XL	<ul style="list-style-type: none"> <li>• ±1200 grams for size Large.</li> <li>• Tool-less multi-adjustable front peak with anti-reflecting underside.</li> <li>• Flexible face trim design with a large nose protector area.</li> <li>• F.A.S. (Full Air System) with 10 ventilation points and double rear extractor.</li> <li>• Integrated rear fin and goggle anti-slip design.</li> <li>• Multi density EPS foam inner shell.</li> <li>• Removable, washable inner liner and cheek pads and liner features sanitized treatment.</li> <li>• Front top pocket for sweat absorbing pads and helmet bag.</li> <li>• Morpho System Plus - Ergonomic 3D cheek pads.</li> <li>• Double D racing buckle.</li> <li>• Aluminum screws, protective coated parts.</li> <li>• D.O.T. and E.C.E. certified.</li> </ul>	<ul style="list-style-type: none"> <li>▶ Less stress on neck and shoulder muscles.</li> <li>▶ Allows quick visor adjustment and reduces glare.</li> <li>▶ Protects from wind and snow.</li> <li>▶ Allows you to control airflow for cooling.</li> <li>▶ Added stability and aerodynamic performance.</li> <li>▶ Superior protection over single-density foams.</li> <li>▶ Keeps your helmet fresh and promotes wicking of moisture.</li> <li>▶ Allows for a better fit.</li> <li>▶ Most secure fastening method.</li> <li>▶ Assures lasting appearance.</li> </ul>	<p>XP-R2 Carbon Light \$399.99</p> <p>XP-R2 Carbon Light Blaze \$424.99</p> <p>XP-R2 Carbon Light Original \$424.99</p>	
XP-3	<p>P. 59</p> <p>SHELL Fiberglass</p>  <p>Ski-Doo XP-3 Pro Cross Scarp 448257    XP-3 Pro Cross 448258    Ski-Doo XP-3 Pro Cross X-Team 448412</p>		<p>Light</p> <p>Very light</p> <p>Ultra light</p>	XS, S, M, L, XL, 2XL	<ul style="list-style-type: none"> <li>• ±1470 grams for size large.</li> <li>• Superlight premium fiberglass shell.</li> <li>• EPS inner liner.</li> <li>• Front stainless steel and rear vent system.</li> <li>• Aero-tuned, fully adjustable visor system.</li> <li>• Removable, washable, and replaceable CoolMax<sup>®</sup> moisture-wicking liner and cheek pads.</li> <li>• Winter breath deflector.</li> <li>• Lightweight double D ring chin strap.</li> <li>• Triple certified: D.O.T., E.C.E. and Snell M2015.</li> </ul>	<ul style="list-style-type: none"> <li>▶ Less stress on neck and shoulder muscles.</li> <li>▶ Impact absorbing protection.</li> <li>▶ Allows control of airflow for cooling or for warmth on cold days.</li> <li>▶ Added stability and aerodynamic performance.</li> <li>▶ Keeps helmet fresh.</li> <li>▶ Most secure fastening method.</li> </ul>	<p>Ski-Doo XP-3 Pro Cross Scarp \$249.99</p> <p>XP-3 Pro Cross \$239.99</p> <p>Ski-Doo XP-3 Pro Cross X-Team \$249.99</p>	
XC-4	<p>P. 60</p> <p>SHELL Polycarbonate Composite</p>  <p>NEW Ladies' XC-4 Cross 448397    XC-4 Cross 448250    XC-4 Cross Drift 448252</p>		<p>Light</p> <p>Very light</p> <p>Ultra light</p>	XS, S, M, L, XL, 2XL	<ul style="list-style-type: none"> <li>• ±1470 grams for size Large.</li> <li>• Polycarbonate composite shell.</li> <li>• EPS inner shell.</li> <li>• Front stainless steel and rear vent system.</li> <li>• Aero-tuned and fully adjustable visor system.</li> <li>• Removable, washable, and replaceable CoolMax moisture-wicking liner and cheek pads.</li> <li>• Winter breath deflector.</li> <li>• Lightweight double D chin strap.</li> <li>• D.O.T. and Snell M2015.</li> </ul>	<ul style="list-style-type: none"> <li>▶ Less stress on neck and shoulder muscles.</li> <li>▶ Impact absorbing protection.</li> <li>▶ Allows control of airflow for cooling or for warmth on cold days.</li> <li>▶ Added stability and aerodynamic performance.</li> <li>▶ Keeps your helmet fresh.</li> <li>▶ Most secure fastening method.</li> </ul>	<p>Ladies' XC-4 Cross Helmet \$159.99</p> <p>XC-4 Cross \$149.99</p> <p>XC-4 Cross Drift \$159.99</p>	
X-1	<p>P. 60</p> <p>SHELL ABS</p>  <p>X-1 Cross 448338    X-1 Cross Triad 448226</p>		<p>Light</p> <p>Very light</p> <p>Ultra light</p>	XS, S, M, L, XL, 2XL	<ul style="list-style-type: none"> <li>• Lightweight and tough.</li> <li>• Adjustable, aero-tuned visor.</li> <li>• Ventilation system.</li> <li>• Moisture-wicking and breathable chin strap, liner and cheek pads.</li> <li>• Easily removable and washable liner and cheek pads.</li> <li>• Strap grip keeps goggle strap in place.</li> <li>• D.O.T. certified.</li> </ul>	<ul style="list-style-type: none"> <li>▶ Added stability and aerodynamic performance.</li> <li>▶ Airflow for cooling.</li> <li>▶ Keeps your helmet fresh.</li> <li>▶ Keeps goggles in place.</li> </ul>	<p>X-1 Cross \$119.99</p> <p>X-1 Cross Triad \$129.99</p>	

# KNOW YOUR HELMET SAFETY RATINGS

Ever wonder what those certification labels on your helmet mean? They are safety standards based on street motorcycling.

## DOT

**DOT** (Department of Transportation - FMVSS 218)  
This is a test that all road-going motorcycle helmets have to pass. Has been the same standard for more than 20 years.

## Snell

**SNELL M2015**  
SNELL is an independent testing organization, and certification is voluntary. SNELL is more rigorous than DOT, and its standards are updated every 5 years – the M2015 standards are the most recent. Continuous tests of production helmets are conducted to ensure compliance.

## ECE22.05

**ECE** (Economic Commission for Europe) **22.05**  
The safety standard most used worldwide, recognized in more than 50 countries and every race organization. Considered very up-to-date. 50 production helmets must pass testing before being certified and continuous tests of production helmets are conducted to ensure compliance.

**WHICH IS BEST?** They are all adequate for snowmobiling. SNELL and ECE are more rigorous, but typically reject features like modular designs. Meeting SNELL and ECE standards generally cost more, so expect to pay more for a helmet certified at that level.

## HOW LONG DOES A HELMET LAST?

Assuming your helmet hasn't taken any hard hits, it should last 5-6 years before the interior foam loses its ability to cushion impacts. Of course, if you have had a hard impact, you should replace your helmet immediately.

# WHAT BACKCOUNTRY EXPERTS WEAR UNDER THE LID.

"On really cold days I use the Mountain Balaclava. As soon as I start to warm up I remove it to prevent fogging. I use the nose piece that comes with my XP-R2 Helmet to reduce fogging because it does a really good job of deflecting my breath down from my goggles."

**JEREMY MERCIER**



**ROB ALFORD**

"I wear a balaclava. For drying my goggles, I put them on my clutch cover during breaks when the sled is shut off. It's important to take off your helmet and goggles when helping dig sleds out to prevent fogging."



"For those deep powder days, I'll wear a balaclava to keep the snow from hitting my neck and going down my jacket and will even add a strip of duct tape on my nose to prevent frostbite on frigid days. I've found the the only way to keep your goggles from fogging up is to keep your head dry with as much airflow as possible, so I ride without the breath deflector."

**TONY JENKINS**



**ASHLEY CHAFFIN**

"My everyday favorite under my helmet is the technical neck gator with my hair tied back in a tight braid. If the riding gets really technical and I'm breathing heavily I can fold the gator down from my face and keep my neck warm. On really cold days, I'll use a Ski-Doo Balaclava. The opening size is key, because I need it to keep my hair out of my eyes and my mouth and nose inside the mask. If my nose is exposed I start to get winded and breathe directly into my goggles – fogging them."

"I don't wear anything under my helmet unless it is colder than 14°F / -10°C. Then I wear a Ski-Doo thin balaclava. I find a great way to combat fogging is to stow an extra pair in the Ski-Doo Goggle Bag on the clutch cover."

**DAVE NORONA**



**JAY MENTABERRY**

When using a **BV2S** or **Modular 3** Helmet we recommend the Mask System Balaclava (447630). This is designed to work with the fog resistant mask and BREATH EVAC systems on these high tech helmets.



## TECH FOCUS



### MODULAR 3

Clear Vision Technology with optically-correct dual lens visor **offers distortion- and fog-free vision.**

Front push-button release integrated into jaw section **allows easy movement when wearing gloves.**

BREATH EVAC fog-resistant mask system with increased vent diameter **controls breathing airflow in and out of helmet.**

### BV2S

Dual lens visor featuring Clear Vision Technology **delivers fog-free 180° peripheral vision.**

Lever-activated sunshield easily adjusts to light conditions.

Removable and washable inner liner **keeps helmet fresh.**

BV2S fog-resistant mask system with soft surgical rubber seal.

The mask system **adapts to all faces with the easy adjust knob.**

Front push-button release for jaw piece **operates easily with gloves on.**





**BV<sub>2</sub>S**  
Simply the highest tech helmet available. Designed for unmatched vision and comfort in even the harshest conditions.

**BV<sub>2</sub>S HELMET**  
Shell: Polycarbonate Composite  
447404  
S, M, L, XL, 2XL, 3XL  
White (01), Yellow (10), Black (90), Matte Black (93)  
**\$449.99**  
DOT



**BV<sub>2</sub>S ELECTRIC SE HELMET**  
Shell: Polycarbonate Composite  
447468  
S, M, L, XL, 2XL, 3XL  
Black (90)  
**\$529.99**  
DOT



**ELECTRIC VISOR**  
448240 • One size  
Clear (00)  
**\$169.99**



**ABSORBENT MASKS**  
• Pack of 5.  
929013 • One size  
White (01)  
**\$7.99**



**HELMET LIGHTING SYSTEM KIT**  
• Batteries are not included.  
447465 • One size  
Black (90)  
**\$39.99**



SEE BV<sub>2</sub>S HELMET FEATURES & BENEFITS P. 50-51

PERFECT MATCH TO SNOWMOBILING'S WARMEST GEAR ON P38



**MODULAR 3**  
Outstanding vision with crystal clear visor and BREATH EVAC system to prevent fogging.



**MODULAR 3 X-TEAM SWIFT HELMET**  
High performance design and features of the Modular 3 helmet, with a look to match.  
Shell: Polycarbonate Composite  
448403  
S, M, L, XL, 2XL, 3XL  
Yellow (10)  
**\$339.99**  
DOT



**LADIES' MODULAR 3 SWIFT HELMET**  
Shell: Polycarbonate Composite  
448404  
S, M, L, XL, 2XL, 3XL  
Ice (38)  
**\$339.99**  
DOT



**MODULAR 3 HELMET**  
Shell: Polycarbonate Composite  
447963 • S, M, L, XL, 2XL, 3XL  
White (01), Grey (09), Hi-Vis Yellow (26), Black (90)  
**\$299.99**  
DOT



**MODULAR 3 ELECTRIC SE HELMET**  
All the great features of the standard Modular 3 helmet, plus an electric shield for extra protection against fogging.  
Shell: Polycarbonate Composite  
447964  
S, M, L, XL, 2XL, 3XL  
Black (90)  
**\$369.99**  
DOT



**ELECTRIC VISOR**  
• Cord included.  
• Sun visor not included.  
448239 • One size  
Clear (00)  
**\$149.99**



**ABSORBENT MASKS**  
• Pack of 10.  
929014 • One size  
White (01)  
**\$7.99**



SEE MODULAR 3 HELMET FEATURES & BENEFITS P. 50-51

SEE MORE HELMET DETAILS IN ACTION AT [WWW.SKI-DOO.COM/GENUINE-PARTS-ACCESSORIES-RIDING-GEAR/CATALOG-VIDEO](http://WWW.SKI-DOO.COM/GENUINE-PARTS-ACCESSORIES-RIDING-GEAR/CATALOG-VIDEO)



**XP-R2**  
Ultra lightweight and strong multi-directional carbon fiber construction with premium style and details.

**XP-R2 CARBON LIGHT HELMET**

Shell: Carbon Fiber Composite  
447656  
XS, S, M, L, XL, 2XL, 3XL  
Black (90)  
**\$399.99**

DOT ECE22.05



**XP-R2 CARBON LIGHT ORIGINAL HELMET**

Shell: Carbon Fiber Composite  
447826  
XS, S, M, L, XL, 2XL, 3XL  
Hi-Vis Yellow (26)  
**\$424.99**

DOT ECE22.05



**XP-R2 CARBON LIGHT BLAZE HELMET**

Shell: Carbon Fiber Composite  
447657  
XS, S, M, L, XL, 2XL, 3XL  
Orange (12)  
**\$424.99**

DOT ECE22.05



**SWEAT ABSORBENT PADS**

• Pack of 10.  
929015 • One size  
White (01)  
**\$7.99**



**MORPHO KIT**

• For a perfect custom fit.  
• Extra cheek pads, for a better fit inside the helmet.  
• Left and right pads included.  
447754 • XS, S, M, L, XL, 2XL, 3XL  
Clear (00)  
**\$14.99**



**XP-3**  
Feature-packed superlight snocross-style helmet for exceptional performance, protection and comfort.

NEW

**SKI-DOO XP-3 PRO CROSS SCARP HELMET**

Shell: Fiberglass  
448257  
XS, S, M, L, XL, 2XL  
Yellow (10), Blue (80)  
**\$249.99**

DOT ECE22.05 Snell



NEW

**SKI-DOO XP-3 PRO CROSS X-TEAM HELMET**

Shell: Fiberglass  
448412  
XS, S, M, L, XL, 2XL  
Silver (08), Orange (12),  
Black (90)  
**\$249.99**

DOT ECE22.05 Snell



**XP-3 PRO CROSS HELMET**

Shell: Fiberglass  
448258  
XS, S, M, L, XL, 2XL  
Matte Black (93)  
**\$239.99**

DOT Snell





**XC-4**  
Fresh look and style with features you expect in more expensive helmets.

**XC-4 CROSS HELMET**

Shell: Polycarbonate Composite

448250  
XS, S, M, L, XL, 2XL  
Black (90)

**\$149.99**

**DOT Snell**



**XC-4 CROSS DRIFT HELMET**

Shell: Polycarbonate Composite

448252 • XS, S, M, L, XL, 2XL  
Yellow (10), Black (90)

**\$159.99**

**DOT Snell**



**NEW**

**LADIES' XC-4 CROSS HELMET**

Shell: Polycarbonate Composite

448397  
XS, S, M, L, XL, 2XL  
Pink (36)

**\$159.99**

**DOT ECE22.05**



**X-1**

Packed with features at an unbeatable price.

**X-1 CROSS HELMET**

Shell: ABS

448338  
XS, S, M, L, XL, 2XL  
Matte Black (93)

**\$119.99**

**DOT**



**X-1 CROSS TRIAD HELMET**

Shell: ABS

448226 • XS, S, M, L, XL, 2XL  
White (01), Yellow (10)

**\$129.99**

**DOT**



**SUBLIMATED BALACLAVA**

- Stretch, antibacterial fabric with brushed inner surface.
  - Moisture-wicking anti-odor treatment.
  - Flatlocked seams prevent skin chafing.
- 91% Polyester, 9% Spandex

**Ladies'**

448381 • One size  
Pink (36)

**\$24.99**

**Men's**

448384 • One size  
Orange (12)

**\$24.99**



**X-TEAM TUBE**

- Multi-purpose, stretch and comfortable tubular headwear.
- 12 different configurations: bandana, headband, balaclava and more.
- Protects from sun, wind, or cold.
- Keeps hair out of face.

• Flatlocked seams to prevent skin chafing.  
94% Cotton, 6% Spandex

454013 • One size • Black (90)

**\$14.99**

**MOUNTAIN BALACLAVA**

- Stretch, quick-dry fabric with brushed inner surface.
- Neoprene face guard for effective moisture exchange to promote breathing in extreme cold with removable rubber part in pocket.
- Flatlocked seams prevent skin chafing.
- Good fit with open face helmets.

65% Nylon, 20% Polyester,  
10% Spandex, 5% Synthetic Rubber

448234 • One size • Black (90)

**\$34.99**



**TECHNICAL NECK GAITOR**

- Keeps you warm while providing breathable, windproof and waterproof performance.
- Moisture-wicking fabric.
- Laser-cut breather holes.
- Ergonomic patterning with microfleece at side and back panel for more stretchability.
- Elastic adjustment at back.

89% Polyester, 8% Spandex,  
3% Synthetic Rubber

447636 • One size • Black (90)

**\$29.99**



**TECHNICAL BALACLAVA**

- Strategically placed mesh for breathability, microfleece for warmth.
- Windproof neck bib.
- Higher at back of neck for increased motion range.
- Flatlocked seams prevent skin chafing.

92% Polyester, 8% Spandex

445950 • One size • Black (90)

**\$29.99**



**BASIC BALACLAVA**

- Designed for warmth, dryness and comfort.
- Flatlocked seams prevent skin chafing.

80% Nylon,  
20% Spandex

447449 • One size  
Black (90)

**\$19.99**



**MICROFLEECE BALACLAVA**

- Stretch, antibacterial warming fleece fabric with brushed inner surface.
- Flatlocked seams prevent skin chafing.

92% Polyester,  
8% Spandex

447565 • One size  
Black (90)

**\$24.99**



**MASK SYSTEM BALACLAVA**

- Perfect to use with BV:S or Modular 3 helmets.
- Keeps you warm while providing breathable and windproof performance.
- Moisture-wicking and waterproof fabric.
- Elastic adjustment at sides.

60% Polyester, 30% Nylon,  
10% Spandex

447630 • S/M, L/XL • Black (90)

**\$29.99**



**NECK GAITOR**

- Spandex binding and elastic at back for a better fit.
- Anti-pilling fleece.

100% Polyester

447634 • One size  
Black (90)

**\$19.99**





### SKI-DOO HELIUM GOGGLES BY SCOTT

- Custom painted frame and strap graphics.
- Thermal dual lens.
- No Fog<sup>1</sup> anti-fog lens treatment.
- 100% UV protected pink Lexan<sup>®</sup> lens.
- Polar shield/face guard.
- Multi-layer face foam.
- Durable anti-slip strap.
- Tear-off and roll-off compatible.
- Ski-Doo by Scott branded.
- Storing pouch included.



#### SKI-DOO HELIUM GOGGLES BY SCOTT

448408 • One size • Grey (09), Yellow (10)

**\$89.99**



#### SKI-DOO HELIUM SPEED STRAP GOGGLES BY SCOTT

• Speed strap helmet attachment system.

448409 • One size • Grey (09), Yellow (10)

**\$94.99**

### SKI-DOO HOLESHOT GOGGLES BY SCOTT

- Custom painted frame and strap graphics.
- Thermal dual lens.
- No Fog anti-fog lens treatment.
- 100% UV protected pink Lexan lens.
- Multi-layer face foam.
- Durable anti-slip strap.
- Tear-off and roll-off compatible.
- Polar shield/face guard.
- Ski-Doo by Scott branded.



#### SKI-DOO HOLESHOT GOGGLES BY SCOTT

447947 • One size • White (01), Yellow (10), Black (90)

**\$74.99**

### SKI-DOO TRAIL GOGGLES BY SCOTT

- Thermal dual lens.
- 100% UV protected pink Lexan lens.
- Hypoallergenic super-soft face foam.
- Durable anti-slip strap.
- Tear-off and roll-off compatible.
- Polar shield/face guard.
- Ski-Doo by Scott branded.



#### SKI-DOO TRAIL GOGGLES BY SCOTT

447946 • One size • White (01), Yellow (10), Black (90)

**\$54.99**

**DID YOU KNOW**  
Matching your goggles to your helmet and your face delivers the best vision and warmth.



#### ADRENALINE ELECTRIC WIRED GOGGLES

- Electric dual lens system for ultimate sub-zero anti-fog and optical performance.
- Large molded urethane frame for strength, flexibility and style.
- Oversized, hypoallergenic dual density face foam for comfort and shock absorption.
- Anti-fog, scratch-resistant amber dual maxflow lens for long lasting clear vision.
- Premium silicone backed strap system for long lasting slip-free performance.
- Hinged strap system for better fit on any facial geometry.
- Clip-on nose guard shield included.
- Storing pouch included.

447867 • One size • Yellow (10)

**\$159.99**

The Helium and Adrenaline goggles pioneered the heated goggle technology. The dual lens electric heating element eliminates fogging for clear vision.



#### HELIUM ELECTRIC WIRELESS GOGGLES

- Wireless electric dual lens system for maximum anti-fog performance and rider mobility.
- Anti-fog, scratch-resistant dual maxflow lens for good visibility in varied light conditions.
- Large, flexible, assembled urethane frame with integrated vents for strength, flexibility and comfort-flow ventilation.
- Oversized, hypoallergenic triple density face foam for comfort and increased shock and sweat absorption.
- Premium silicone backed strap system for long lasting slip-free performance.
- Dual hinged strap system for optimum fit on any facial geometry.
- Clip-on nose guard shield included.
- 110V battery charger.

447827 • One size • Silver (08)

**\$229.99**



#### SKI-DOO HOLESHOT SPEED STRAP GOGGLES BY SCOTT

• Speed strap helmet attachment system.

447956 • One size • White (01), Yellow (10), Black (90)

**\$79.99**



#### SKI-DOO HOLESHOT OVER THE GLASSES GOGGLES BY SCOTT

447948 • One size • Black (90)

**\$84.99**





**DID YOU KNOW** OutDry Backcountry and OutDry Highmark gloves are so waterproof you can submerge your hands in water and they will be dry.

Learn everything about the Ski-Doo gloves in action. [www.ski-doo.com/genuine-parts-accessories-riding-gear/catalog-video](http://www.ski-doo.com/genuine-parts-accessories-riding-gear/catalog-video)

### OUTDRY+ HIGHMARK GLOVES

Short-cuff gloves specifically designed for mountain riding.



- |  |  |
|--|--|
| 1. Maximal Abrasion Resistance Super Fabric  | 7. Goggle Wiper  |
| 2. 7mm Padding                               | 8. Kevlar+ Thread Reinforcement                        |
| 3. Reflective Material                       | 9. Ax Suede Connect Fabric for Touchscreen Sensitivity |
| 4. Woven Nylon with Teflon Protection Fabric | 10. 0.75 mm Ultra Strong Synthetic Suede               |
| 5. Neoprene Cuff for Maximal Adjustment      |  |
| 6. Texturized Indogoaat Leather              |  |

The OutDry membrane is waterproof, windproof, extremely breathable and designed specifically for gloves. It is uniquely bonded to the outer fabric, preventing water and wind from constantly cooling your hands.



#### OUTDRY HIGHMARK GLOVES

The OutDry waterproof membrane delivers bar feel you've never experienced before.

- OutDry membrane technology is waterproof and windproof.
- Fingers are shaped and articulated with stretch fabric at knuckles.
- Extra tacky leather palm with Kevlar stitching.
- Nylon Cordura knuckles with padding.
- Short wrist with adjustable gauntlet.
- X-STATIC mesh antibacterial lining.
- PrimaLoft Gold insulation on back of hand.

**Shell:** Nylon, Neoprene, Cordura  
**Palm:** Leather, Nash  
**Insulation:** PrimaLoft Gold  
 446279 • S, M, L, XL, 2XL, 3XL • Black (90)  
**\$189.99**



#### OUTDRY BACKCOUNTRY GLOVES

This moderate temperature glove uses an OutDry membrane for maximum breathable waterproofness with superior feel and grip.

- Antibacterial X-STATIC mesh inner liner.
- Articulated fingers and padded knuckles.
- Leather on palm and thumb for secure grip and control.
- Adjustable gauntlet and wrist.

**Shell:** Leather, Nylon, Cordura  
**Palm:** Leather, Perforated Leather  
**Insulation:** PrimaLoft Gold  
 446256 • S, M, L, XL, 2XL, 3XL  
 Black (90)  
**\$189.99**



#### GRIP GLOVES

High performance insulated glove with great grip, feel.

- mcTEX waterproof, windproof and breathable glove insert.
- mcFIT technology for a better grip.
- Insulated backhand only, for warmth without compromising feel.
- Print design on backhand to minimise snow accumulation.
- Rubber finger print for improved grip.
- Shaped fingers.
- Box fingertips to avoid air infiltration.
- Neoprene wrist with adjustment.
- Padded and reinforced palm.
- Visor wiper.

**Shell:** Leather, Nylon, Chloroprene Rubber, Polyester  
**Insulation:** PrimaLoft Gold  
 446234 • S, M, L, XL, 2XL, 3XL  
 Blue (80), Black (90)  
**\$74.99**

**DID YOU KNOW** mcFit manufacturing technology bonds, rather than sews, the inner layers of the gloves together, so that you get the best feel, grip and performance.



#### MOUNTAIN GLOVES

Uninsulated glove for bar feel in mild weather.

- mcFIT technology for a better grip.
- Mild-weather glove with lining.
- Hipora waterproof, windproof and breathable glove insert.
- Shaped fingers.
- Velcro adjustment for easy sleeve fit.

**Shell:** Nylon, Leather  
 446222 • S, M, L, XL, 2XL, 3XL  
 Black (90)  
**\$59.99**



#### LADIES' MCODE MITTS

- Hipora membrane for added breathability.
- Inner glove design for cozy feeling.
- Antibacterial, stay-dry moisture management lining.
- Clarino suede palm with silicone for extra grip.

**Shell:** Nylon, Neoprene  
**Palm:** Clarino Nash Suede  
**Insulation:** PrimaLoft Gold  
 446261 • XS, S, M, L, XL, 2XL  
 Black (90)  
**\$74.99**



The OutDry membrane is waterproof, windproof, extremely breathable and designed specifically for gloves. It is uniquely bonded to the outer fabric, preventing water and wind from constantly cooling your hands.

### OUTDRY TRAIL PERFORMANCE GLOVES

Cold weather glove with superior handlebar feel and the OutDry advantages of being waterproof, windproof and breathable.

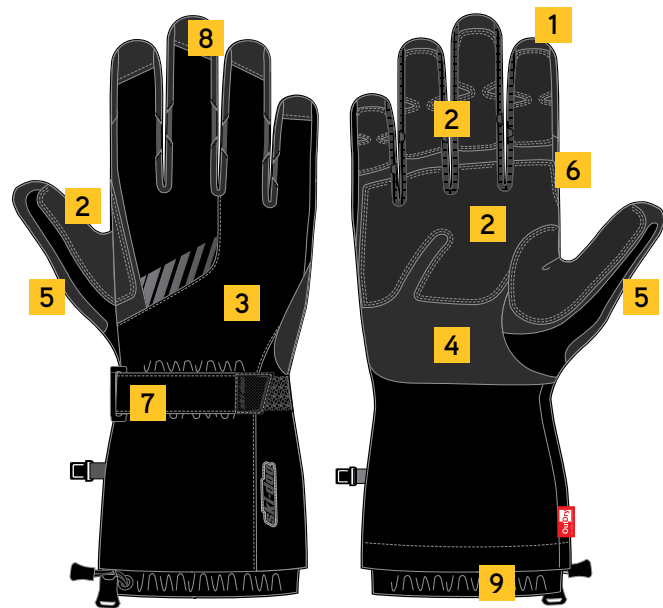

1. Ax Suede Connect Fabric works on touchscreens
2. Ax Suede provides maximum abrasion resistance for secure grip and control
3. PrimaLoft Gold insulation on back hand
4. PrimaLoft Gold with Grip Control in palm
5. Goggle wiper
6. Kevlar thread reinforcement
7. Internal mid cinch system
8. Wraparound construction blocks wind at fingertips
9. Antibacterial X-STATIC mesh liner

**NEW** **OutDry**

#### OUTDRY TRAIL PERFORMANCE GLOVES

- Cold weather design.
- OutDry membrane for maximum waterproofness, windproofness, breathability, superior grip and feel.
- Articulated fingers.

Shell: Nylon, Leather, Polyester  
Insulation: PrimaLoft Gold

446265 • XS, S, M, L, XL, 2XL, 3XL  
Black (90)

**\$219.99**



#### X-TEAM LEATHER GLOVES

Rugged, proven leather construction in a warm insulated glove.

- mcFIT technology for a better grip.
- Hipora waterproof, windproof and breathable glove insert.
- Antibacterial, stay-dry moisture management lining.
- Padded knuckles.
- Shaped, articulated fingers.
- Box fingertips to avoid air infiltration.
- Reinforced rubberized non-slip grip.
- Visor wiper.
- Wide opening gauntlet with adjustable wrist.

Shell: Leather, Nylon, Polyester  
Insulation: PrimaLoft Gold

446219 • S, M, L, XL, 2XL, 3XL  
Black (90), Sunburst Yellow (96)

**\$114.99**



#### X-TEAM NYLON GLOVES

- Hipora waterproof, windproof and breathable membrane glove insert.
- mcFIT technology for a better grip.
- Antibacterial, stay-dry moisture management lining.
- Rubber palm and fingertips for improved grip.
- Padded knuckles.
- Shaped, articulated knuckles and fingers.
- Box fingertips to avoid cold air infiltration.
- Added backhand insulation for maximum protection.
- Wrist adjustment strap system.
- Visor wiper.

Shell: Nylon  
Insulation: PrimaLoft Gold

446220 • XS, S, M, L, XL, 2XL, 3XL  
Black (90), Sunburst Yellow (96)

**\$84.99**



#### SNO-X GLOVES

A favorite among riders for good reason. An excellent glove for comfort in all riding conditions.

- Stay-dry moisture management lining.
- Hipora waterproof, windproof and breathable glove insert.
- Stretch texturized fabric to facilitate movement.
- Padded knuckles.
- Rubber palm and fingertips for improved grip.
- Adjustable wrists.

Shell: Spandex, Neoprene, Nylon  
Palm: Synthetic Nash Suede  
Insulation: Thermolite

446202 • S, M, L, XL, 2XL, 3XL  
Black (90), Sunburst Yellow (96)

**\$64.99**



#### X-TEAM CREW GLOVES

A lightweight glove without insulation for warm weather riding or for hand protection during short stops.

- Soft, durable, flexible and breathable.
- Backhand lined with 2-way stretch texturized Spandex for maximum flexibility and fit.
- Neoprene wrists for easy sleeve fit.
- Durable rubber finger patches.

Shell: Soft shell, Perforated Leather, Leather, Neoprene  
Palm: Synthetic Leather

446278 • S, M, L, XL, 2XL, 3XL  
Black (90)

**\$49.99**



**NEW**



**ABSOLUTE 0 GLOVES**

Gloves that earn the Absolute 0 name. Built for extreme cold using proven high quality materials.

- Nylon outer shell with leather reinforced palm.
- Antibacterial, stay-dry moisture management lining.
- Visor wiper.
- Waterguard® membrane.

Shell: Nylon, Leather, Polyester  
Insulation: PrimaLoft Gold

446282 • XS, S, M, L, XL, 2XL, 3XL  
Black (90)

**\$114.99**



**ABSOLUTE 0 MITTS**

A mitt built for extreme cold.

- Nylon outer construction with leather reinforced palm.
- Inner glove design.
- Antibacterial, stay-dry moisture management lining.
- Visor wiper.
- Waterguard® membrane.

Shell: Nylon, Leather, Polyester  
Insulation: Down, PrimaLoft Gold

446283 • XS, S, M, L, XL, 2XL  
Black (90)

**\$109.99**



**UTILITY GLOVES**

Snowmobile gloves with tough leather palm and knuckles specifically designed for getting the job done.

- Leather palm with split cow leather reinforcement and cushion.
- Leather with logo at knuckles.
- Shaped and articulated fingers for maximum grip.
- Extra tacky leather on palm and thumb for grip.
- PrimaLoft Gold insulation on back of hand.

Shell: Nylon, Leather, Cordura  
Palm: Leather

Insulation: PrimaLoft Gold

446287 • XS, S, M, L, XL, 2XL, 3XL  
Black (90)

**\$84.99**



**HOLESHOT GLOVES**

A great glove for comfort in all riding conditions.

- High wrist cuff to keep wind out.
- Hipora waterproof, windproof and breathable glove insert.
- Added backhand insulation for maximum protection.
- Thinner-insulated palm for increased dexterity.
- Articulated, shaped fingers.
- PVC padded knuckles.
- Extra-grip rubberized palm and thumb.
- Adjustable gauntlet and wrist.

Shell: Nylon  
Insulation: Thermal Loft

446206 • S, M, L, XL, 2XL, 3XL  
Red (30), Black (90)

**\$64.99**



Watch the Expedition Jacket & Highpants and Utility Gloves' work features.  
[www.ski-doo.com/genuine-parts-accessories-riding-gear/catalog-video](http://www.ski-doo.com/genuine-parts-accessories-riding-gear/catalog-video)



**LADIES' MUSKOKA GLOVES**

Extra warm nylon gloves with leather palm and fingers.

- Hipora waterproof, windproof and breathable glove insert.
- Ultra comfortable synthetic fur lining.
- Added backhand insulation for maximum protection.
- Thinner-insulated palm for increased dexterity.
- Box fingertips to avoid cold air infiltration.
- Shaped fingers.
- Silicone fingertips for better grip.
- Wide opening gauntlet with adjustable wrist.

Shell: Nylon  
Insulation: PrimaLoft Gold

446238 • S, M, L, XL, 2XL  
Black (90)

**\$79.99**



**LADIES' MUSKOKA MITTS**

Extra warm nylon mitts with leather palm.

- Inner glove design for cozy feeling.
- Antibacterial, stay-dry moisture management lining.
- Articulated finger area for easy hand movement.
- Long 14" (35 cm) gauntlet with adjustable wrist.

Shell: Nylon  
Palm: Leather

Insulation: PrimaLoft Gold

446257 • S, M, L, XL, 2XL  
Pink (36), Black (90)

**\$79.99**



**REVERSIBLE BEANIE**

- 2 in 1 reversible hat.
- Band micro-fleece lining.
- 50% Wool, 50% Acrylic

448380 • One size • Orange (12), Red (30), Black (90), Sunburst Yellow (96)

**\$24.99**



**RETRO BEANIE**

- Microfleece lining.
- 85% Acrylic, 15% Wool

447939 • One size • Grey (09), Sunburst Yellow (96)

**\$19.99**



Men's



Ladies'

**VINTAGE RABBIT FUR HAT**

- Soft leather-lined with real rabbit fur.
- Attachment on side.

Men's

445897 • One size • Black (90)

**\$79.99**

Ladies'

447580 • One size • White (01), Black (90)

**\$79.99**



**LADIES' KNITTED HAT**

- Microfleece band lining.
- 85% Acrylic, 15% Wool

448383 • One size • Grey (09), Pink (36), Sunburst Yellow (96)

**\$24.99**



**LADIES' MUSKOKA HAT**

- Microfleece lining.
- 59% Acrylic, 26% Nylon, 15% Wool

447929 • One size • White (01), Charcoal Grey (07), Teal (74)

**\$24.99**



Learn more about Ski-Doo boots and see them in action. [www.ski-doo.com/genuine-parts-accessories-riding-gear/catalog-video](http://www.ski-doo.com/genuine-parts-accessories-riding-gear/catalog-video)



**SKI-DOO TEC+ BOOTS**  
Designed for active riders who demand performance and comfort.  
• Features the best materials and construction for superior fit and comfort while keeping feet dry and warm.  
• Moisture-wicking inner liner material.  
• Half sizes available with insole inserts.  
• Use of a technical sock is recommended for best performance.  
444217 • 7, 8, 9, 10, 11, 12, 13 • Black (90)  
**\$234.99**



**LADIES' SKI-DOO TEC+ BOOTS**  
All the same features of the Ski-Doo TEC + Boots, with feminine look.  
444212 • 7, 8, 9, 10, 11 White (01)  
**\$234.99**

**SKI-DOO TEC+ BOOTS UNIQUE FEATURES**



1. Leather outer layer incorporates COSMO<sup>®</sup> HydroGuard<sup>®</sup> waterproof membrane.
2. 600 g PrimaLoft ECO FOOTWEAR insulation for maximum comfort.
3. PoRon<sup>®</sup> XRD<sup>®</sup> extreme impact protection in tongue for lower shin.
4. Tapered rear shape for better achilles and ankle support.
5. Rear upper cut away for improved walking.
6. Aggressive, durable anti-slip outsole for running board traction.
7. Abrasion and impact resistant ice breaker toe piece.
8. Kevlar reinforced laces.



**SKI-DOO REBEL BOOTS**  
• Designed for all-purpose trail riding.  
• Waterproof membrane.  
• Synthetic leather upper.  
• Thinsulate insulation.  
444160 • 7, 8, 9, 10, 11, 12, 13 Black (90)  
**\$154.99**



**LADIES' SKI-DOO REBEL BOOTS**  
• Same features as Ski-Doo Rebel Boots with feminine styling  
444168 • 6, 7, 8, 9, 10 Charcoal Grey (07)  
**\$154.99**



**NEOPRENE SUPREME BOOTS**  
Multi-purpose boots deliver warmth, comfort and are 100% waterproof.  
• Built in handles.  
• Rugged outsole.  
• Aggressive tread design.  
• Multi purpose boots.  
• Neoprene construction.  
444219 • 7, 8, 9, 10, 11, 12, 13 Black (90)  
**\$159.99**

- 400 g PrimaLoft insulation.
- Dri-Lex liner.
- 100% waterproof.
- Vulcanized seamless outer shell.
- Comfort-rated to -58°F (-50°C).
- Note: Use of moisture-wicking technical socks is recommended.

**ULTRALIGHT SOCKS**

• Warm and comfortable moisture-wicking for dry feet at all times.  
• Extreme resistance to cold and active management of perspiration moisture.  
• Dri-release<sup>®</sup> wool combines latest-generation ease of care of synthetic fabric and look of natural fiber.  
• Elastic ankle and arch support.  
42% Polyester, 34% Polyamide Nylon, 16% Polypropylene, 6% Merino Wool, 2% Elastane  
444136 • S/M, L/XL Black (90)  
**\$9.99**



Men's

**ACTIVE / RACE SOCKS**

• Moisture-wicking for dry feet at all times.  
• Engineer-knitted with Isofil<sup>®</sup> yarn designed to keep skin dry, with built-in polypropylene fibers that trap warm air and slow the dispersion of body heat.  
• Elastic ankle and arch support.  
• Reinforced toe and heel, plus added protection above the boot line thanks to over-the-calf length.  
• Special padding for pressure reduction and buffered protection.  
45% Polyamide Nylon, 35% Merino Wool, 18% Polypropylene, 2% Elastane  
Men's 444138 • S/M, L/XL Yellow (10), Red (30)  
**\$24.99**



Men's

Ladies'

**THERMAL SOCKS**

• Socks for extreme cold.  
• Same thickness as competing thermal socks, but lighter, warmer and better moisture-wicking performance.  
• Thermolite<sup>®</sup> hollow-core fibers deliver new generation of warmth-comfort fusion.  
• Elastic ankle and arch support.  
• Fully cushioned shin segment.  
50% Polyester Thermolite, 32% Polyamide Nylon, 13% Merino Wool, 3% Acrylic, 2% Elastane  
Men's 444140 • S/M, L/XL Black (90)  
**\$19.99**



Men's

Ladies'



### SKI-DOO ELEVATION BACKPACK

- Lightweight and clever backpack specially designed for active riding.
- 8-liter main storage compartment.
- Ski-Doo branded.

100% Polyester

469266 • One size • Black (90)

**\$109.99**

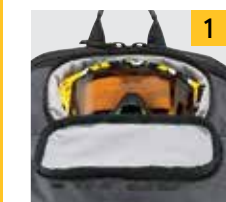

1

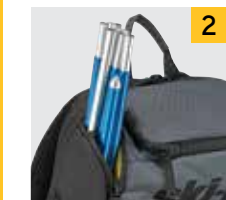

2

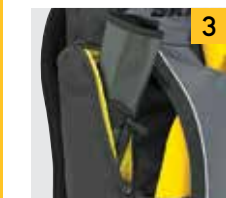

3



### SKI-DOO ELEVATION BACKPACK FEATURES

1. Velvety top pocket for extra goggles or small electronics.
2. Closed probe pocket.
3. Tool pocket with removable tool pouch.
4. Side attach accessory holder for snow shovel.
5. 2-point shoulder strap settings with torso adjustment.
6. Circulation back channels.
7. Ergonomic waist strap with two easy-access pockets.



### SKI-DOO CARRIER 9800 GEAR BAG BY OGIO

- Premium carry bag for all your gear.
- Structural Load Equalization Deck (SLED) wheeled chassis system.
- Wide mouth lid opening for easy access to all compartments and specialty pockets.
- iFom® integrated foam panel construction throughout entire bag for added protection.
- Adjustable main compartment dividers.
- Multiple zippered mesh organization pockets.
- Front accessory pocket and secure hold compression straps.
- Oversized heavy-duty treaded wheels.
- Telescoping pull handle.
- 16" H x 17" W x 36" D (40 cm x 43 cm x 91 cm).

75% Polyester, 25% Plastic

447837 • One size • Black (90)

**\$274.99**



### SKI-DOO CARRIER DRY BACKPACK BY OGIO

- Completely waterproof rolltop design.
- Constructed of 420-denier nylon for durability.
- Dual-density shoulder straps and adjustable sternum strap.
- Quick-access front pocket.
- Organization panel with 2 zip pockets on inside.
- Laptop and tablet sleeves.
- 360-degree reflective print.
- Removable high visibility liner.
- 20.5" H (rolled) x 10.5" W x 6.75" D (52 cm x 27 cm x 17 cm).
- 1600 Cu. In./26 L. capacity.

100% Polyester

447958 • One size • Black (90)

**\$139.99**



### SKI-DOO ALTITUDE BACKPACK BY OGIO

- 2-point shoulder strap adjustment with torso adjustment.
- Ergonomic waist strap.
- Dual exit points.
- Removable tool pouch.
- Side attach accessory holder (e.g. snow shovel and probe).
- 1 expandable storage compartment, 1 main compartment and 1 easy-access pocket.
- Circulation back channels.

100% Polyester

447339 • One size • Black (90)

**\$89.99**



### SKI-DOO CARRIER BACKPACK BY OGIO

- Padded interior laptop compartment fits most 17" laptops.
- iFom integrated panels keep your electronics and other valuables protected.
- Padded iPad® / tablet / e-reader sleeve.
- Large main compartment.
- Comfortable padded back panel.
- Adjustable ergonomic shoulder straps.
- Zippered fleece lined top valuables pocket.
- Dual side beverage / accessory holders.
- 19" H x 13" W x 7.5" D (48 cm x 83 cm x 19 cm).

100% Polyester

447836 • One size • Black (90)

**\$79.99**

### SKI-DOO CARRIER 8800 GEAR BAG BY OGIO

- Heavy-duty chassis with oversized treaded wheels.
- Wide mouth U-shaped opening for easy access to all gear.
- Large main ventilated compartment and multi-use dual end pockets.
- Secondary end pocket with accessory organization sleeves.
- iFom integrated foam panel construction throughout for added gear protection.
- Telescoping pull handle and padded adjustable shoulder strap.
- Easy grab end handles for transport.
- 15" H x 18" W x 32" D (38 cm x 46 cm x 81 cm).

90% Polyester, 10% Plastic

447851 • One size • Black (90)

**\$164.99**



### SKI-DOO HELMET CASE

- Easy-carry ergonomic handle.
- Helmet accessory outer pocket (helmet not included).

100% Polyester

447640 • One size • Black (90)

**\$29.99**



### SKI-DOO CARRIER DUFFLE BAG BY OGIO

- High-tensile strength, durable, lightweight construction.
- Ventilated shoe compartment (holds two pairs).
- Zippered front accessory pocket.
- Large main compartment with additional end storage pocket.
- Padded, ventilated and adjustable shoulder strap.
- Molded carry handle.
- Durable abrasion-resistant base.
- High visibility liner.
- 11" H x 9.75" W x 25" D (28 cm x 25 cm x 64 cm).

100% Polyester

447838 • One size • Black (90)

**\$69.99**



### SKI-DOO CARRIER HEAD CASE BY OGIO

- Oversized helmet bag fits all helmet brands and sizes with fins and without.
- iFom integrated foam panels and fleece interior provide the ultimate in protection.
- Protective zipper closure prevents scratches from zippers.
- Easy-access oversized external pocket for goggles, lenses and tear-offs.
- Exterior zippered accessory pocket.
- Durable reinforced bottom.
- 11" H x 13" W x 19" D (28 cm x 33 cm x 48 cm).

100% Polyester

447707 • One size • Black (90)

**\$49.99**



### SUPER SPORT TEK VEST

- The ultimate upper-body protector for all trail riders regardless of age, gender or experience level.
- Zip-off fleece collar comes standard.
  - Convenient front zipper access.
  - Reverse-entry, 2-stage pocket design.
  - Works best with 3-in-1 jackets with a zip-out lining.
  - Ski-Doo logos.

469267 • S, M, L, XL  
Black (90)

**\$339.99**

469270 • 2XL  
Black (90)

**\$369.99**



**SPORTSWEAR**

Shop on [store.ski-doo.com](https://store.ski-doo.com) or visit your Ski-Doo dealer





**X-TEAM HOODIE**

- Semi-fitted hooded sweatshirt.
- Center front opening.
- Hidden handwarmer pockets.

60% Cotton, 40% Polyester  
**453761 • S, M, L, XL, 2XL, 3XL**  
 Grey (09), Black (90)  
**\$74.99**



**SKI-DOO GENERIC HOODIE**

- One side brushed fleece.
- Hidden handwarmer pockets.

80% Cotton, 20% Polyester  
**453767 • S, M, L, XL, 2XL, 3XL • Black (90)**  
**\$69.99**



**OVERSHIRT**

- Fleece overshirt with light quilted insulating lining for warmth.

60% Cotton, 40% Polyester Fleece  
**453763 • XS, S, M, L, XL, 2XL • Black (90)**  
**\$79.99**



**SNO-X FLEECE**

- Full zip with 2 front hip pockets.
- X-Team embroidered logo.
- Bonded fleece heavy mid layer.

100% Polyester  
**453769 • XS, S, M, L, XL, 2XL, 3XL • Orange (12), Black (90)**  
**\$89.99**



**MCODE MID LAYER**

Great mid layer choice with MCode attitude.

- Mid layer thermal fleece. softness and non-pilling.
- Brushed interior for moisture-wicking.
- Antibacterial to reduce odors.
- Handwarmer pockets.

95% Polyester, 5% Spandex  
**453777 • S, M, L, XL, 2XL, 3XL • Green (70), Blue (80)**  
**\$99.99**

**SKI-DOO WINTERBREAK HOODIE**

- Semi-fitted hooded sweatshirt with water-repellent performance.
- Hidden handwarmer pockets.

80% Cotton, 20% Polyester  
**453722**  
 S, M, L, XL, 2XL, 3XL  
 Black (90), Sunburst Yellow (96)  
**\$74.99**



**WEEKENDER HOODIE**

- Textured polyester fleece with brushed interior for softness.
- Hidden pockets.

100% Polyester  
**453727**  
 S, M, L, XL, 2XL  
 Black (90)  
**\$89.99**



**OVERSHIRT**

- Plaid flannel overshirt.
- Front opening with press buttons.
- Two chest pockets.
- Warm plush interior.

100% Cotton / 100% Polyester lining  
**453795**  
 XS, S, M, L, XL, 2XL  
 Red (30)  
**\$69.99**



**X-TEAM MICROFLEECE**

- Zippered handwarmer pockets.
- Welded pocket outline.
- X-Team embroidered logo on sleeve.

100% Polyester  
**453762 • S, M, L, XL, 2XL, 3XL • Grey (09), Black (90)**  
**\$69.99**



**SKI-DOO ZIP UP MID LAYER**

- Brush effect fabric inside.

100% Polyester Mesh  
**453766 • S, M, L, XL, 2XL, 3XL • Charcoal Grey (07), Black (90)**  
**\$89.99**



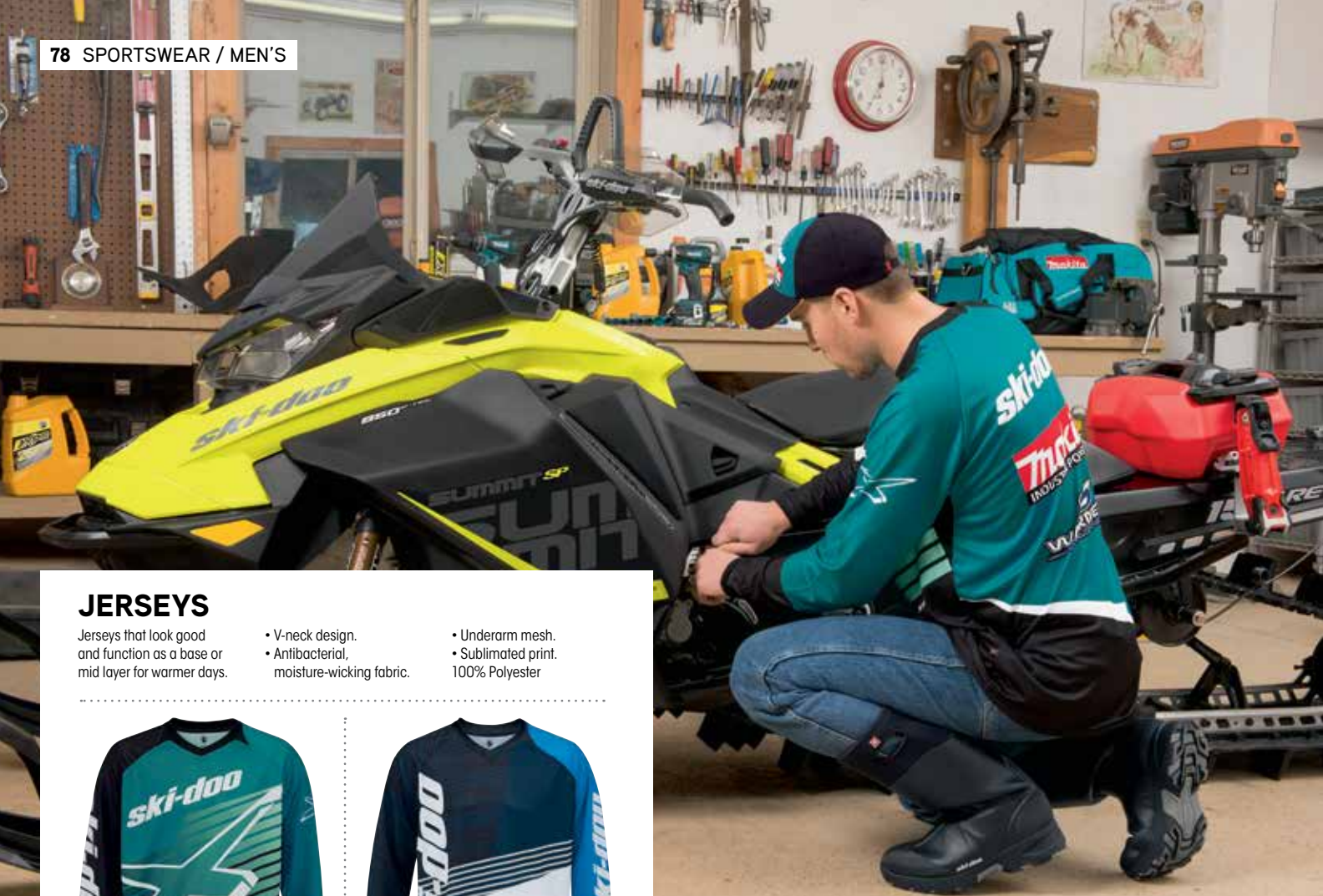

**JERSEYS**

Jerseys that look good and function as a base or mid layer for warmer days.

- V-neck design.
- Antibacterial, moisture-wicking fabric.
- Underarm mesh.
- Sublimated print.
- 100% Polyester



**NEW**  
**SKI-DOO WARNERT  
MAKITA TEAM RACE  
EDITION JERSEY**

453825  
S, M, L, XL, 2XL  
Teal (74)  
**\$49.99**



**NEW**  
**HIGHMARK JERSEY**

453815  
S, M, L, XL, 2XL  
Blue (80)  
**\$49.99**



**X-TEAM JERSEY**

453788  
S, M, L, XL, 2XL

Grey (09), Orange (12)  
**\$49.99**



**SKI-DOO LONG SLEEVE T-SHIRT**

• Ski-Doo logo on front.  
100% Cotton  
453790  
S, M, L, XL, 2XL, 3XL  
Khaki (05), Black (90)  
**\$34.99**



**NEW**

**RIDE T-SHIRT**

• Ski-Doo Logo on front.  
100% Cotton  
453812  
S, M, L, XL, 2XL, 3XL  
Khaki (05), Whiskey (28)  
**\$24.99**



**X-TEAM TURTLENECK**

• Stretch fabric.  
• Collar rib and cuff rib.  
95% Cotton, 5% Spandex  
453610  
M, L, XL, 2XL  
Black (90)  
**\$34.99**

**X-TEAM T-SHIRT**

100% Cotton  
453813  
S, M, L, XL, 2XL, 3XL  
Khaki (05), Charcoal Grey (07),  
Blue (80), Black (90)  
**\$24.99**



**SKI-DOO T-SHIRT**

100% Cotton  
453699  
S, M, L, XL, 2XL, 3XL  
Heather Grey (27), Whiskey (28),  
Black (90), Sunburst Yellow (96),  
**\$21.99**



**VINTAGE T-SHIRT**

• Semi-fitted t-shirt.  
• 1979 vintage look.  
Ice: 98% Cotton, 2% Polyester  
Black: 60% Polyester, 40% Cotton  
453798  
S, M, L, XL, 2XL, 3XL  
Ice (38), Black (90)  
**\$24.99**



**SKI-DOO MCODE  
T-SHIRT**

100% Cotton  
453785  
S, M, L, XL, 2XL, 3XL  
Black (90)  
**\$24.99**





**X-TEAM FLAT CAP**

- Fitted stretch twill cap.
- Flat peak.

97% Cotton, 3% Spandex

447978

S/M, L/XL, 2XL

Black (90)

**\$24.99**



**NEW**

**SKI-DOO WARNER  
MAKITA TEAM RACE  
EDITION CAP**

- Metal adjuster with BRP logo.
- Embroidered race team logos on front.
- X-Team 3D logo on right side.

100% Cotton

447234 • One size • Teal (74)

**\$24.99**



**FREESTYLE CAP**

- Fitted stretch twill cap.
- Flat peak.
- Striped print on the peak and front left panel.

97% Cotton, 3% Spandex

447924

S/M, L/XL

Black (90), Sunburst Yellow (96)

**\$24.99**



**X-TEAM CAP**

- Metal adjuster with BRP logo.
- Embroidered X-Team logo on right side.

- Embroidered Ski-Doo signature on left side.

100% Cotton

448379 • One size • Red (30), Black (90), Sunburst Yellow (96)

**\$19.99**



**SKI-DOO CLASSIC CAP**

- Metal adjuster with BRP logo.
- 3D Ski-Doo logo on the front.

- Print on left side.

100% Cotton

447926 • One size • Yellow (10), Black (90)

**\$24.99**

**GROWING PASSION  
FOR FREERIDING  
TO THE  
XX  
POWER**

Meet Erika Lindblad and Caroline Ohlsson, backcountry riders from Sweden. These ladies could not keep their passion for backcountry riding to themselves and created the women-only XX Freeride Camp. Now in its third year, the camp brings more than 60 riders together to progress their freeriding skills and share their passion for shredding.



**CAROLINE OHLSSON**

**SLED**

Summit X 163

**FAVORITE RIDING LOCATION**

Hemavan, Saxnas, and Riksgransen in Sweden

**PASSION**

Erika and I share a passion to increase interest in sledding among female riders, and we are happy to see more women enjoying the sport. We organize the XX Freeride Camp, where we get four days on sleds with 60 other girls! I also feel passionate about developing my snowmobiling. I like the challenge and adrenaline that a day on the sled gives me. Every ride I get more courage – and that is a must to keep on progressing.

My interest in freeriding has had another big benefit – the chance to meet many new friends. As Erika says, "During winter, all the friends out in the snow become family." And that is really how I feel. I am lucky to have such a big and wonderful family!

**GEAR**

XP-R2 Helmet lets me ride long days without feeling heavy or my neck getting tired. Revy One-Piece suit gives me great mobility while keeping snow from getting between a jacket and pants. The Ladies' MCode Jacket and Pants' 3-in-1 design means I can wear the shell most of the time and then put on the insulated liner jacket for the ride home when it's colder.

**MOST FUN ON A SLED EVER**

I can't say because that changes so often. Year after year, it keeps getting better and better. But days when I get to be out riding with friends, having fun in the powder are moments I will cherish forever!



**SLED**

Summit X 154

**FAVORITE RIDING LOCATION**

Bangnas and Riksgransen in Sweden

**PASSION**

Inspiring others to try new things and explore the world. When I think of how far we have come boosting female riders both locally and internationally with the XX Freeriders project, it makes me so thrilled. I can't stop smiling every time I see another girl out sledding, as it was not that common a couple of years ago. I am also passionate about learning new skills on the sled; it is a challenge to grasp all the technical parts of freeriding but great achievements comes from practice. Finally, I love to travel and explore new places.

**GEAR**

The Revy One-Piece suit is definitely my favorite. It keeps me dry no matter what weather conditions we have. Since my heart is all yellow, the color works perfect for me. As an alternative, I often use the MCode Jacket and Helium Pants. Whichever set of clothing, I always use the new Ski-Doo TEC+ Boots, which work for active riders and is designed with a great female look that suits me. Love them!

**MOST FUN ON A SLED EVER**

The XX Freeride Camp and XX Spring Ride events, for sure. I love sledding with other people with the same interests and spending time with both new and existing sled buddies. During the winter season, all the friends out in the snow becomes family.



**ERIKA LINDBLAD**





**X-TEAM HOODIE**

Stylish and refined X-Team look that's proud, but not too loud.

- Semi fitted hooded sweatshirt.
- Full zipper.
- Hidden handwarmer pockets.

72% Cotton, 23% Polyester, 5% Spandex

453759 • XS, S, M, L, XL, 2XL • Grey (09), Black (90)

**\$74.99**



**RIDER T-SHIRT**

- Feminine fit.
- Raglan sleeve with burnout fabric effect.
- V-neck.
- Vintage logo at front.

95% Cotton, 5% Spandex

453783 • XS, S, M, L, XL, 2XL • Charcoal Grey (07)

**\$34.99**



**MUSKOKA LONG SLEEVE TEE**

- Extra wide hood / collar all in one.
- Long bracelet sleeve with shirring effect.
- Feminine fit.
- Ski-Doo signature at front and back.
- Lace drawcord for collar adjustment.

100% Cotton

453726 • XS, S, M, L, XL, 2XL • Heather Grey (27)

**\$44.99**



**SUPREME FLEECE**

- Slim cut to flatter your figure.
- Stand-up collar helps keep neck cozy.

- Zippered handwarmer pockets and one zip-pocket on left chest.

100% Polyester

453631 • XS, S, M, L, XL, 2XL • Ice (38), Raspberry (39), Black (90)

**\$69.99**



**X-TEAM MICROFLEECE**

- 2 zippered hand pockets.
- Embroidered Ski-Doo logo.

- Large embossed X logo at back.

100% Polyester

453768 • XS, S, M, L, XL, 2XL • Grey (09), Pink (36), Black (90)

**\$69.99**



**MUSKOKA FLEECE**

- Full zip with 2 front hip pockets.
- Ski-Doo rubberized logo.
- Bonded fleece heavy mid layer.

100% Polyester

453773 • XS, S, M, L, XL, 2XL • Heather Grey (27)

**\$69.99**



**WEEKENDER ZIP UP SWEATER**

- Textured polyester fleece with brushed interior for softness.
- Comfortable fit.

100% Polyester

453729 • XS, S, M, L, XL, 2XL • Grey (09)

**\$69.99**



**LOUNGE JACKET**

- One side brushed.
- Handwarmer pockets.

95% Polyester, 5% Spandex

453666 • XS, S, M, L, XL, 2XL • Black (90)

**\$59.99**



**LOUNGE PANTS**

- One side brushed.

95% Polyester, 5% Spandex

453667 • XS, S, M, L, XL, 2XL • Black (90)

**\$54.99**



**X-TEAM JERSEY**

Jersey that looks good and function as a base or mid layer for warmer days.

- Semi-fitted V-neck made from quick-dry, antibacterial, moisture-wicking fabric.
- Underarm mesh.
- Sublimated print.

100% Polyester

453787 • XS, S, M, L, XL, 2XL • Yellow (10), Pink (36)

**\$49.99**





**MUSKOKA T-SHIRT**  
 • Fitted style. • Stretch fabric.  
 95% Cotton, 5% Spandex  
 453786 • XS, S, M, L, XL, 2XL • Pink (36), Black (90)  
**\$24.99**



**X-TEAM T-SHIRT**  
 • Fitted style. • Stretch fabric.  
 95% Cotton, 5% Spandex  
 453801 • XS, S, M, L, XL, 2XL • Pink (36), Blue (80), Black (90)  
**\$24.99**

**MUSKOKA CAP**  
 • Adjustable cap.  
 • Metal badge Ski-Doo logo on right side.  
 • Print on left side and on the peak.  
 100% Cotton Twill  
 448378 • One size • Black (90)  
**\$19.99**



**OVERSHIRT**  
 • Plaid flannel overshirt.  
 • Front opening with press buttons.  
 • Two chest pockets.  
 • Plush silky fabric lining.  
 100% Cotton / 100% Polyester lining  
 453728 • XS, S, M, L, XL, 2XL • Mixed Color (18)  
**\$69.99**



**HOW TO MEASURE**

- For best results, have someone else take measurements.
- Measure body in underwear.
- Tape must be snug but not tight.
- If measurements fall between two sizes, order the larger size.

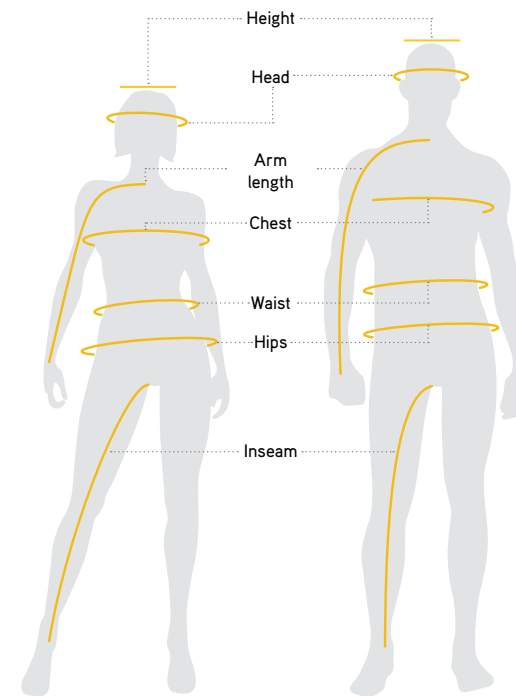

**Height:** without shoes, standing with heels and back against a wall.  
**Head:** around your head, from the center of the forehead, above the ears and over the natural bump at the back of the head.  
**Arm length:** let the hands hang down on the side in a slightly bent position. Measure from the center of the back of your neck, along the length of your arm, to the wrist.  
**Chest:** measure under your arm, around the fullest part of your chest.  
**Waist:** immediately below the lowest rib.  
**Hips:** across the fullest part of the seat.  
**Inseam:** without shoes, from crotch to the floor.

**WHAT CODE REPRESENTS YOUR SIZE?**

- 1 Find your size.
- 2 The corresponding code is THE CODE you use to complete the part number on your order.  
 Example: 440 227 90  
 Size: M = code "06",  
 Therefore 440 227 06 90

SIZE	CODE	SIZE	CODE	SIZE	CODE
One Size	00	4XLT	19	13	33
XS	02	5XL	88	14	34
S	04	1	20	16	35
M	06	2	21	3-4	79
MT	07	3	22	5-6	52
L	09	4	23	6-8	48
LT	10	5	24	7-8	54
XL	12	6	25	10-12	49
XLT	13	7	27	14-16	50
2XL	14	8	28	S/M	72
2XLT	15	9	29	M/L	91
3XL	16	10	30	L/XL	73
3XLT	17	11	31		
4XL	18	12	32		

	MEN'S - REGULAR 5'8" - 6'0"								
	XS	S	M	L	XL	2XL	3XL	4XL	5XL
Chest	33-35	35-37	37-40	40-44	44-48	48-52	52-56	56-59	59-63
Waist	27-29	29-31	31-34	34-38	38-42	42-46	46-50	50-53	53-62
Hips (Seat)	33-35	35-37	37-40	40-44	44-48	48-52	52-56	56-59	59-68
Arm Length	30	31	32	33	34	35	35	36	36
Inseam	31	31½	32	32	32	32	32½	32½	33

	MEN'S - TALL 6'1" - 6'4" Arm length + 1.5" Inseam + 2.0"					
	MT	LT	XLT	2XLT	3XLT	4XLT
Chest	37-40	40-44	44-48	48-52	52-56	56-59
Waist	31-34	34-38	38-42	42-46	46-50	50-53
Hips (Seat)	37-40	40-44	44-48	48-52	52-56	56-59
Arm Length	33½	34½	35½	36½	36½	37½
Inseam	34	34	34	34	34½	34½

	LADIES' - REGULAR 5'4" - 5'8"						
	XS	S	M	L	XL	2XL	3XL
Chest	32-34	34-36	36-39	39-42	42-45	45-49	49-53
Waist	24-26	26-28	28-30	30-34	34-37	37-41	41-45
Hips (Seat)	34-36	36-38	38-40	40-44	44-47	47-51	51-55
Arm Length	31	31	32	32	33	33	34
Inseam	30	30	30	30	30	30½	30½

	KIDS & TEEN										
	2	3	4	5	6	7	8	10	12	14	16
Height	2'11"	3'2"	3'5"	3'8"	3'11"	4'2"	4'5"	4'8"	4'11"	5'2"	5'5"
Chest	21	22	23	24	25	26	27	28½	30	31½	33
Waist	20	20½	21	21½	22	22½	23	24	25	26	27
Hips (Seat)	21	22	23	24	25	26	27	28½	30	31½	33
Arm Length	15½	17	18½	20	21½	23	24½	28½	30	31½	33
Inseam	13½	15½	17½	19½	21	22¾	24½	26½	28	29½	31

	SOCKS		
	S/M	L/XL	One Size
Men	6½ - 9	9½ - 12½	--
Ladies	5½ - 7½	8 - 10½	--
Kids	9½ - 12½	13 - 3	--
Teen	--	--	3½ - 6

	GLOVES & MITTS Measure Palm Width						
	XS	S	M	L	XL	2XL	3XL
<b>Men</b>							
Inches	3	3¼	3½	4	4½	5	5½
cm	7½	8	9	10	11½	13	14
<b>Ladies</b>							
Inches	2½	2¾	3	3½	4	4½	-
cm	6	7	8	9	10	11½	-

	HELMETS						
	XS	S	M	L	XL	2XL	3XL
Head (cm)	53 - 54	55 - 56	57 - 58	59 - 60	61 - 62	63 - 64	65 - 66
Head (Inches)	20⅞ - 21¼	21⅝ - 22	22⅜ - 22¾	23⅞ - 23⅝	24 - 24⅜	24¾ - 25⅝	25½ - 25⅞

	JUNIOR HELMET		
	S	M	L
Head (cm)	49 - 50	51 - 52	53 - 54
Head (Inches)	19¼ - 19¾	20 - 20½	20⅞ - 21¼

OUR TEEN RIDING GEAR. YOUR NEXT RIDING BUDDY.

# TEENWEAR

SKI-DOO



## X-1 HELMETS

- High-tech, lightweight and tough.
- Fully-adjustable, aero-tuned peak.
- Ventilation system.
- Moisture-wicking and breathable chin strap, liner and cheek pads.
- Easily removable and washable liner and cheek pads.
- Provides maximum visibility.
- Fits all goggles.
- Breath deflector mask included.
- Strap grip keeps goggle strap in place.
- Available with clear-coated bold waterslide graphics.
- D.O.T. certified.

Shell: ABS



### X-1 BLAZE HELMET

447673 • S, M, L • Orange (12)

\$109.99



### X-1 DOODLE HELMET

447966 • S, M, L • Silver (08)

\$119.99

## BASIC BALACLAVA

- Designed for warmth, dryness and comfort.
- Flatlocked seams to prevent skin chafing.

80% Nylon, 20% Spandex

445685 • S/M, L/XL  
Black (90)

\$15.99



## SKI-DOO TRAIL GOGGLES BY SCOTT

- Integrated custom painted frame and strap graphics.
- Pink dual lens.
- No Fog anti-fog lens treatment.
- Durable anti-slip strap.
- 100% UV protected clear Lexan lens.
- Multi-layer hypoallergenic face foam.
- Ski-Doo by Scott branded.

447944 • One size  
Black with graphics (94)

\$54.99



## LONG KNITTED HAT

- 2 in 1 reversible hat.
- 100% Acrylic

448235 • One size  
Whiskey (28), Raspberry (39)

\$19.99



RPM

## X-TEAM JACKET

- Stylish jacket for the teens.
- Includes all the features required for cold temperatures.
- Critical seams sealed.
- Adjustable hem and wrists.
- Microfleece wrists.
- Shaped sleeves.
- Removable insulated hood.
- Powder skirt.
- 2 pockets.

Shell: 100% Polyester  
Insulation: Thermal Loft  
440725 • 7, 8, 10, 12, 14, 16  
Whiskey (28), Pink (36)

\$179.99



RPM

## X-TEAM HIGHPANTS

- Rugged design and construction for active teens.
- 100% waterproof.
- Growing-leg system with zipper for lengthening legs by 4" as child gets taller.
- Critical seams sealed.
- Full front and back bib.
- Shaped and reinforced knees.
- Side zipper opening.
- Elastic waist.
- Storm gaiters.

Shell: 71% Nylon, 29% Polyester  
Insulation: Thermal Loft  
441579 • 7, 8, 10, 12, 14, 16  
Whiskey (28), Black (90)

\$119.99



RPM

## TEEN PANTS

- Growing-leg system for lengthening legs by 4" as child gets taller.
- Critical seams sealed.
- Adjustable waist.
- Shaped and reinforced knees.
- Reinforced seat.
- Fleece at seat for more comfort.
- Side zipper opening at bottom.
- Storm gaiters.

Shell: 80% Nylon, 20% Polyester  
Insulation: Thermal Loft  
441524 • 7, 8, 10, 12, 14, 16  
Black (90)

\$109.99



## X-TEAM GLOVES

- Waterproof and breathable membrane.
- 4-way stretch fleece cuff.
- Drawstring closure.
- Adjustable hook and loop web strap.
- Brushed polyester lining with Microban® anti-microbial product protection.

Shell: 65% Nylon, 20% Polyurethane, 15% Stretch Polyester  
Insulation: Thermal Loft

446289 • 6-8, 10-12, 14-16  
Black (90)

\$39.99



## X-TEAM MITTS

- Waterproof and breathable membrane.
- Drawstring closure.
- Adjustable hook and loop web strap with slip keep.
- Micro-polyester lining with Microban anti-microbial product protection.
- Heat pack pocket built into inner mitt lining.

Shell: Nylon  
Insulation: Thermal Loft

446245 • 6-8, 10-12, 14-16  
Black (90)

\$34.99



## X-TEAM BOOTS

- Unisex boots.
- Waterproof.
- Rubber outline.
- 6 mm thick removable liner.
- Height: 12" (30.5 cm).
- Comfort-rated to -61°F (-52°C).

100% Polyester  
444194 • 1, 2, 3, 4, 5, 6  
Black (90)

\$109.99



## X-TEAM FLEECE

- Handwarmer pockets.
- X-Team embroidery at back.

100% Polyester  
453772  
7-8, 10-12, 14-16  
Pink (36), Sunburst Yellow (96)

\$59.99



OUR KIDS CLOTHING. YOUR NEXT SNOWMOBILER.

# KIDSWEAR

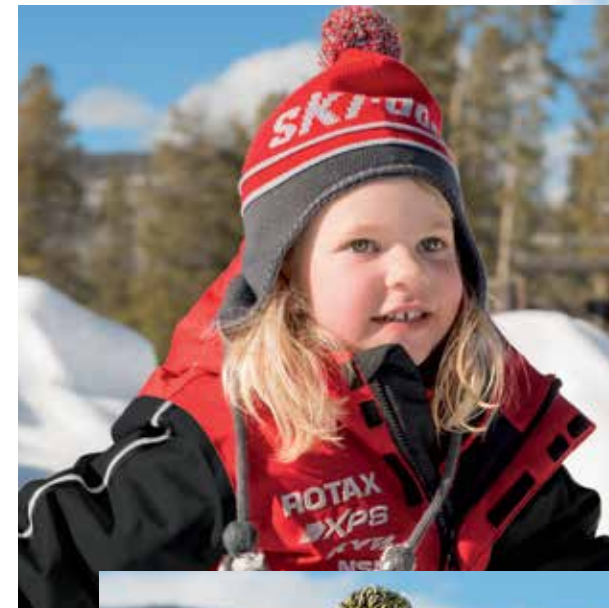

# SKI-DOO

**RPM**

## X-TEAM JACKET

- X-Team style in a smaller-size jacket.
- Critical seams sealed.
- Adjustable hem and wrists.
- Lycra wrists.
- New shaped sleeves.
- Removable insulated hood.
- New double collar seals.
- Powder skirt.

Shell: 82% Nylon, 18% Polyester  
 Insulation: Thermal Loft  
 440717 • 2, 3, 4, 5, 6  
 Red (30), Sunburst Yellow (96)  
**\$129.99**



**RPM**

## X-TEAM HIGHPANTS

- Rugged design and construction for active kids.
- 100% waterproof.
- Growing-leg system with zipper for lengthening legs by 4" as child gets taller.
- Critical seams sealed.
- Full front and back bib.
- Shaped and reinforced knees.
- Side zipper opening.
- Elastic waist.
- Storm gaiters.

Shell: 68% Nylon, 32% Polyester  
 Insulation: Thermal Loft  
 441581 • 2, 3, 4, 5, 6  
 Black (90)  
**\$109.99**



## X-TEAM MITTS

- Waterproof and breathable membrane.
- Drawstring closure.
- Adjustable hook and loop web strap with slip keep.
- Micro-polyester lining with Microban anti-microbial product protection.
- Heat pack pocket built into inner mitt lining.

Shell: Nylon  
 Insulation: Thermal Loft  
 446281 • 2, 4, 6  
 Black (90)  
**\$34.99**



## RACING PERUVIAN HAT

- Knitted hat with microfleece lining.
  - 100% Acrylic
- 447937 • One size  
 Red (30), Sunburst Yellow (96)  
**\$19.99**



## X-TEAM FLEECE

- Mid weight polar fleece.
- Handwarmer pockets.
- X-Team embroidery at back.

100% Polyester  
 453778 • 2, 3-4, 5-6  
 Sunburst Yellow (96)  
**\$44.99**



## THERMAL SOCKS

- Dependable comfort sourced from the durability of Polyamide Nylon and the warmth of Merino Wool.
- Stay-up comfort top keeps socks up.
- Itch-free and shrink treated to retain their size and shape for years.
- Elastic ankle and arch support.
- Fully cushioned shin segment.

35% Merino Wool, 35% Acrylic, 28% Polyamide Nylon, 2% Elastane  
 444151 • S/M, L/XL  
 Charcoal Grey (07), Yellow (10)  
**\$14.99**





WHAT MATTERS IS MAKING IT YOURS

# SKI-DOO ACCESSORIES



 More than 70 items are available for the REV platform 4<sup>th</sup> generation.



Connect with us:    Share your ideas for accessories, get new product releases, enter contests on our online community.

# WHICH ACCESSORIES FIT YOUR RIDE?

Descriptions in this catalog are followed by a list of **PLATFORMS** such as REV, REV-XP, REV-XR, REV-XS, REV-XM, REV-XU and REV (G4) which tell what accessories fit which models.

**Use this chart to determine which platform you have.**

Includes sm  
Ready for Win  
**REV (G4)**  
860201260  
REV-XM, R  
860200602

MODEL	ENGINE	PLATFORM
MXZ	800R E-TEC, 800R PowerT.E.K., 600RS, 600 E-TEC, 600 ACE, 600, 550 FAN	REV-XP
MXZ	1200	REV-XR
Renegade	800R E-TEC, 800R PowerT.E.K., 600 E-TEC, 600 ACE, 550 FAN	REV-XP
Renegade	1200	REV-XR
GSX	600 E-TEC	REV-XP
GSX	1200	REV-XR
Grand Touring	1200, 600 E-TEC	REV-XR
Grand Touring	600, 600 ACE, 550 FAN	REV-XP
Summit	800R E-TEC, 800R PowerT.E.K., 600 E-TEC, 600 ACE, 550 FAN	REV-XP
Freeride™	800R E-TEC	REV-XP
Expedition	1200, 600 E-TEC	REV-XU
Expedition	600 ACE, 550 FAN	REV-XP
Tundra	600 E-TEC, 600 ACE, 550 FAN	REV-XU
Skandic® WT	600 E-TEC, 600 ACE, 550 FAN	REV-XU
MXZ	800R E-TEC, 600RS, 600 E-TEC, 600 ACE, 550 FAN	REV-XP
MXZ	1200	REV-XR
Renegade	800R E-TEC, 600 E-TEC, 600 ACE, 550 FAN	REV-XP
Renegade	1200	REV-XR
GSX LE	600 E-TEC	REV-XP
GSX SE	1200, 800R E-TEC, 600 E-TEC	REV-XR
Grand Touring	1200, 600 E-TEC	REV-XR
Grand Touring	600, 600 ACE, 550 FAN	REV-XP
Summit	800R E-TEC, 800R PowerT.E.K., 600 E-TEC, 600	REV-XP
Freeride	800R E-TEC	REV-XP
Expedition	1200, 600 E-TEC	REV-XU
Expedition	600 ACE, 550 FAN	REV-XP
Tundra	600 E-TEC, 600 ACE, 550 FAN	REV-XU
Skandic	600 E-TEC, 600 ACE, 550 FAN	REV-XU

2011

2012



REV-XU Tundra



REV-XP



REV-XU Expedition



REV-XM



REV-XS

2013

2014

MODEL	ENGINE	PLATFORM
MXZ X-RS™	800R E-TEC, 600RS, 600 E-TEC	REV-XP
MXZ X®	800R E-TEC, 600 E-TEC	REV-XS™
MXZ X	1200	REV-XR
MXZ TNT™	800R E-TEC	REV-XS
MXZ TNT	600 E-TEC	REV-XP
MXZ TNT	1200	REV-XR
MXZ Sport	600, 600 ACE, 550 FAN	REV-XP
Renegade X®	800R E-TEC, 600 E-TEC	REV-XS
Renegade X	1200	REV-XR
Renegade Backcountry™ X®	800R E-TEC, 600 E-TEC	REV-XS
Renegade Adrenaline	800R E-TEC, 600 E-TEC	REV-XP
Renegade Adrenaline	1200	REV-XR
Renegade Backcountry	800R E-TEC, 600 E-TEC	REV-XP
Renegade Sport	600 ACE, 550 FAN	REV-XP
GSX LE	600 E-TEC	REV-XP
GSX SE	1200, 800R E-TEC, 600 E-TEC	REV-XR
Grand Touring	1200, 600 E-TEC	REV-XR
Grand Touring	600 ACE, 550 FAN	REV-XP
Summit	800R E-TEC	REV-XM™
Summit	800R PowerT.E.K., 600 E-TEC, 600	REV-XP
Freeride	800R E-TEC	REV-XP
Expedition	1200, 600 E-TEC	REV-XU
Expedition	600, 550 FAN	REV-XP
Tundra	600 E-TEC, 600 ACE, 550 FAN	REV-XU
Skandic	600 E-TEC, 600 ACE, 550 FAN	REV-XU
MXZ X-RS, X	800R E-TEC, 600 E-TEC	REV-XS
MXZ X	1200	REV-XR
MXZ TNT	800R E-TEC, 600 E-TEC, 900 ACE	REV-XS
MXZ TNT	1200	REV-XR
MXZ Sport	600, 600 ACE, 550 FAN	REV-XP
Renegade X, Adrenaline	800R E-TEC, 600 E-TEC, 900 ACE	REV-XS
Renegade X, Adrenaline	1200	REV-XR
Renegade Backcountry X	800R E-TEC, 600 E-TEC	REV-XS
Renegade Backcountry	800R E-TEC, 600 E-TEC	REV-XS
Renegade Sport	600 ACE, 550 FAN	REV-XP
GSX LE	600 E-TEC, 900 ACE	REV-XS
GSX SE	1200, 800R E-TEC, 600 E-TEC	REV-XR
Grand Touring	1200, 600 E-TEC	REV-XR
Grand Touring	600, 600 ACE, 550 FAN	REV-XP
Summit X, SP	800R E-TEC, 600 H.O. E-TEC	REV-XM
Summit Sport	800R PowerT.E.K., 600	REV-XP



REV-XS



REV-XS



REV-XS



REV-XS



REV-XU Expedition



REV-XM



MODEL	ENGINE	PLATFORM
Freeride	800R E-TEC	REV-XM
Expedition	1200, 600 E-TEC	REV-XU
Expedition	600 ACE, 550 FAN	REV-XP
Expedition	900 ACE	REV-XS
Tundra	600 E-TEC, 600 ACE, 550 FAN	REV-XU
Skandic	600 E-TEC, 600 ACE, 550 FAN	REV-XU

MXZ X-RS, X	800R E-TEC, 600 H.O. E-TEC	REV-XS
MXZ X	1200 4-TEC	REV-XR
MXZ TNT	800R E-TEC, 600 H.O. E-TEC, 900 ACE	REV-XS
MXZ TNT	1200 4-TEC	REV-XR
MXZ Sport	600 ACE	REV-XS
MXZ Sport	600	REV-XP
Renegade® X-RS®, X, Adrenaline	800R E-TEC, 600 H.O. E-TEC, 900 ACE	REV-XS
Renegade X, Adrenaline	1200 4-TEC	REV-XR
Renegade Backcountry X	800R E-TEC	REV-XS
Renegade Backcountry	800R E-TEC, 600 H.O. E-TEC	REV-XS
Renegade Sport	600 ACE	REV-XS
Renegade Sport	600	REV-XP

GSX LE	600 H.O. E-TEC, 900 ACE	REV-XS
GSX LE	1200 4-TEC	REV-XR
GSX SE	800R E-TEC, 600 H.O. E-TEC, 1200 4-TEC	REV-XR
Grand Touring	1200 4-TEC, 900 ACE, 600 H.O. E-TEC	REV-XR
Grand Touring Sport	550 Fan	REV-XP
Grand Touring Sport	600 ACE	REV-XS
Summit X W/T3, X, SP	800R E-TEC, 600 H.O. E-TEC	REV-XM
Summit Sport	800 PowerT.E.K., 600	REV-XP
Freeride	800R E-TEC	REV-XM
Expedition Sport	900 ACE, 600 ACE	REV-XS
Expedition Sport	550 Fan	REV-XP
Expedition LE, SE	All	REV-XU
Tundra	All	REV-XU
Skandic	All	REV-XU

MXZ X-RS, X,	800R E-TEC, 600 H.O. E-TEC, 1200 4-TEC	REV-XS
MXZ Blizzard, TNT	800R E-TEC, 600 H.O. E-TEC, 1200 4-TEC, 900 ACE	REV-XS
MXZ Sport	600 ACE	REV-XS
MXZ Sport	600	REV-XP



REV-XS



REV-XS



REV-XP



REV-XU Expedition



REV-XU



REV-XS

MODEL	ENGINE	PLATFORM
Renegade® X-RS®, X, Adrenaline	800R E-TEC, 600 H.O. E-TEC, 1200 4-TEC, 900 ACE	REV-XS
Renegade Enduro	800R E-TEC, 600 H.O. E-TEC, 1200 4-TEC, 900 ACE	REV-XS
Renegade Backcountry X	800R E-TEC	REV-XM
Renegade Backcountry	800R E-TEC, 600 H.O. E-TEC	REV-XM
Renegade Sport	600 ACE	REV-XS
Renegade Sport	600	REV-XP
Grand Touring	1200 4-TEC, 900 ACE, 600 H.O. E-TEC	REV-XS
Grand Touring Sport	600 ACE	REV-XS
Summit X W/T3, X, SP	800R E-TEC, 600 H.O. E-TEC	REV-XM
Summit Sport	800 PowerT.E.K., 600	REV-XP
Freeride	800R E-TEC	REV-XM
Expedition Sport	900 ACE, 600 ACE	REV-XS
Expedition Sport	550 Fan	REV-XP
Expedition LE, SE, Xtreme	All	REV-XU
Tundra	All	REV-XU
Skandic	All	REV-XU

MXZ X-RS, X,	800R E-TEC, 600 H.O. E-TEC, 1200 4-TEC	REV-XS
MXZ X, TNT	850 E-TEC	REV (G4)
MXZ Blizzard, TNT	800R E-TEC, 600 H.O. E-TEC, 1200 4-TEC, 900 ACE	REV-XS
MXZ Sport	600 ACE	REV-XS
MXZ Sport	600	REV-XP
Renegade X-RS, X, Adrenaline	800R E-TEC, 600 H.O. E-TEC, 1200 4-TEC, 900 ACE	REV-XS
Renegade X, Adrenaline	850 E-TEC	REV (G4)
Renegade Enduro	800R E-TEC, 600 H.O. E-TEC, 1200 4-TEC, 900 ACE	REV-XS
Renegade Backcountry X	800R E-TEC	REV-XM
Renegade Backcountry	800R E-TEC, 600 H.O. E-TEC	REV-XM
Renegade Sport	600 ACE	REV-XS
Renegade Sport	600	REV-XP

Grand Touring SE, LE	1200 4-TEC, 900 ACE, 600 H.O. E-TEC	REV-XS
Grand Touring Sport	600 ACE	REV-XS
Summit X, SP 165, 154	850 E-TEC	REV (G4)
Summit X W/T3, X, SP	800R E-TEC, 600 H.O. E-TEC	REV-XM
Summit Sport	600	REV-XP
Freeride	800R E-TEC	REV-XM
Expedition Sport	900 ACE, 600 ACE	REV-XS
Expedition Sport	550 Fan	REV-XP
Expedition LE, SE, Xtreme	All	REV-XU
Tundra	All	REV-XU
Skandic	All	REV-XU



REV-XS



REV-XM



REV-XS



REV-XM



REV-XP



REV (G4)

You can also visit the Ski-Doo Owners Center: [www.ski-doo.com/owners/previous-model-years](http://www.ski-doo.com/owners/previous-model-years)

You can also visit the Ski-Doo Owners Center: [www.ski-doo.com/owners/previous-model-years](http://www.ski-doo.com/owners/previous-model-years)

# AT THE PEAK OF PERFORMANCE

The very pinnacle of snowmobile performance is in the Pro classes of the ISOC Snocross National Circuit. We shadowed one of our long time partners, Warnert Racing for the first few races of the 2015-2016 season to show you what it's like. The team runs MXZx 600RS race sleds and has been using XPS oils and wearing Ski-Doo gear for over 15 years. Its racers come all the way from Europe to compete at the highest level: John Stenberg, from Sweden, races in the premier Pro Open class; Elias Ishoel hails from Norway and competes in Pro Lite.



Ishoel landing on the front straight at Canterbury Park in Minnesota.

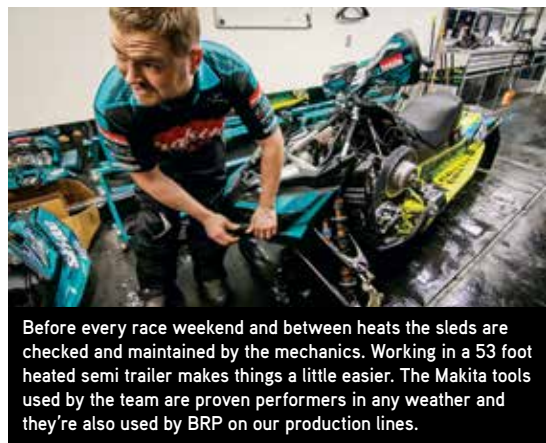

Stenberg flies the finish at Canterbury.

Before every race weekend and between heats the sleds are checked and maintained by the mechanics. Working in a 53 foot heated semi trailer makes things a little easier. The Makita tools used by the team are proven performers in any weather and they're also used by BRP on our production lines.

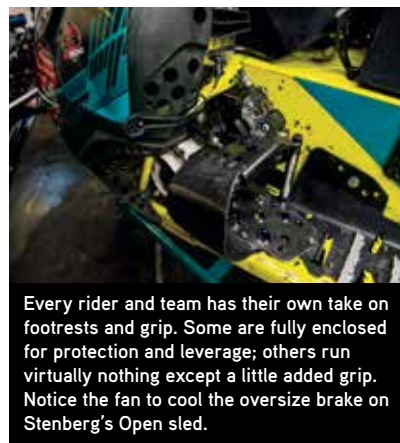

Every rider and team has their own take on footrests and grip. Some are fully enclosed for protection and leverage; others run virtually nothing except a little added grip. Notice the fan to cool the oversize brake on Stenberg's Open sled.

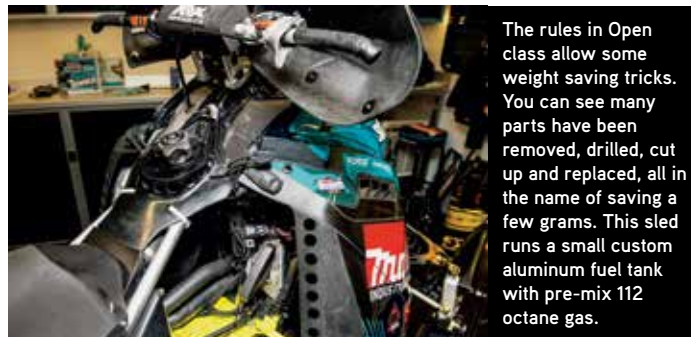

The rules in Open class allow some weight saving tricks. You can see many parts have been removed, drilled, cut up and replaced, all in the name of saving a few grams. This sled runs a small custom aluminum fuel tank with pre-mix 112 octane gas.



The team relies on KYB shocks, like on our top consumer sleds, with fine tuning and maintenance by KYB/Enzo professional technicians. In Snocross the track is constantly changing, so shock calibration changes are frequent throughout the race weekend. Racing isn't possible without sponsors and GMC, NSK Bearings and Kicker Speakers help with quality products and support.

Ishoel's Pro-Lite sled (200) is a stock MXZx 600RS with some customizations for his preferences. Stenberg's Pro Open sled (259) starts with a stock chassis and engine, then adds twin tuned pipes and high compression heads, different airbox, lightweight hood and more. You can also see some of the weight saving ideas the team uses.



Strategy is important - especially at the starting line - so Stenberg talks with his mechanic before the Canterbury race, which featured a radical raised starting line.



# SUMMIT SP 850 E-TEC

OUR PERFECTLY-INTEGRATED ACCESSORIES. YOUR NEXT SUPER TECHNICAL LINE.

See the video of this accessorized sled. Go to: [www.ski-doo.com/genuine-parts-accessories-riding-gear/catalog-video](http://www.ski-doo.com/genuine-parts-accessories-riding-gear/catalog-video)



GET 1 YEAR FACTORY WARRANTY\* ON BRP ACCESSORIES. INSTALLED BY YOU OR YOUR DEALER.

<b>1</b>	<b>FULL BODY SKID PLATE</b> 860201441	<b>\$129.99</b>	<b>6</b>	<b>LinQ SNOWBOARD / SKI RACK</b> 860201255	<b>\$399.99</b>
<b>2</b>	<b>STACKABLE LinQ FUEL CADDY - 15 L</b> 860201265	<b>\$169.99</b>	<b>7</b>	<b>LinQ PREMIUM TUNNEL BAG - SHORT 10 + 3 L</b> 860200622	<b>\$144.99</b>
<b>3</b>	<b>TRANSPARENT HANDLEBAR AIR DEFLECTORS</b> 860201254	<b>\$89.99</b>	<b>8</b>	<b>HEAVY-DUTY REAR BUMPER</b> 860201431	<b>\$249.99</b>
<b>4</b>	<b>ADJUSTABLE RISER FOR STRAIGHT HANDLEBAR</b> 860201276	<b>\$164.99</b>	<b>9</b>	<b>LinQ ERGO SUMMIT BAG</b> 860201355	<b>\$109.99</b>
<b>5</b>	<b>ERGO ADJUSTABLE TOE-HOLDS</b> 860201370	<b>\$229.99</b>			

<b>LEVEL 1</b>	<b>ACCESSORIES COST</b>	<b>\$784.95</b>
	<b>MONTHLY PAYMENT FOR 60 MONTHS*</b>	<b>\$15.51</b>

<b>LEVEL 2</b>	<b>ACCESSORIES COST</b>	<b>\$1,689.91</b>
	<b>MONTHLY PAYMENT FOR 60 MONTHS*</b>	<b>\$17.88</b>

\*Certain conditions may apply. ©2016 Bombardier Recreational Products Inc. (BRP). All rights reserved. ®, ™ and the BRP logo are trademarks of BRP or its affiliates. All other trademarks are the property of their respective owners. In the U.S.A., products are distributed by BRP US Inc. Offers valid in U.S.A. only. The terms and conditions may vary depending on your state and these offers are subject to termination or change at any time without notice. Prices are based on Manufacturer Suggested Retail Price (MSRP) and are valid as of January 31, 2016. Dealers may sell for a different price. Taxes not included. \*Monthly payments for 60 months: estimated with ANNUAL PERCENTAGE RATE at 6.9% for 60 months, for Tiers A - C customers only. ANNUAL PERCENTAGE RATES valid as of January 31, 2016 are subject to change. These financing programs are offered by Sheffield Financial, a Division of Branch Banking and Trust Company, Member FDIC. Subject to credit approval. Approval, and any rates and terms provided, are based on credit worthiness. Other financing offers are available. Rate advertised is based on minimum bureau risk score of 660. Minimum Amount Financed \$1,500; Maximum Amount Financed \$50,000. Other qualifications and restrictions may apply. Financing promotions void where prohibited. BRP is not responsible for any errors, changes or actions related to financing provided by Sheffield Financial. Down payment may be required. MSRP and monthly payments do not include the vehicle, pre-delivery inspection, installation, freight, taxes, title and registration fees. Your actual purchase price may be different due to rebates, promotions, fees and credit qualification. See an authorized BRP dealer for details. BRP reserves the right, at any time, to discontinue or change specifications, prices, designs, features, models, or equipment without incurring any obligations. Some models depicted may include optional equipment. Always consult your snowmobile dealer when selecting a snowmobile for your particular needs and carefully read and pay special attention to your Operator's Guide, Safety Video, Safety Handbook and to the safety labelling on your snowmobile. Always ride responsibly and safely. Always wear appropriate clothing, including a helmet. Always observe applicable local laws and regulations. Don't drink and drive. Printed in Canada.

# MXZ X 850 E-TEC

OUR PERFECT-FIT ACCESSORIES. YOUR NEXT PERFECT CORNER.

▶ See the video of this accessorized sled. Go to: [www.ski-doo.com/genuine-parts-accessories-riding-gear/catalog-video](http://www.ski-doo.com/genuine-parts-accessories-riding-gear/catalog-video)



GET 1 YEAR FACTORY WARRANTY\* ON BRP ACCESSORIES. INSTALLED BY YOU OR YOUR DEALER.

- |          |  |                 |          |  |                 |
|----------|--|-----------------|----------|--|-----------------|
| <b>1</b> | <b>FULL BODY SKID PLATE</b><br>860201441                     | <b>\$129.99</b> | <b>6</b> | <b>SR 21 L LinQ TUNNEL BAG</b><br>860201273                          | <b>\$179.99</b> |
| <b>2</b> | <b>STACKABLE LinQ FUEL CADDY - 15 L</b><br>860201265         | <b>\$169.99</b> | <b>7</b> | <b>SIGNATURE LED LIGHT FOR HANDLEBAR AIR DEFLECTORS</b><br>860201406 | <b>\$124.99</b> |
| <b>3</b> | <b>GLOVEBOX EXTENSION / GPS SUPPORT</b><br>860201249         | <b>\$99.99</b>  | <b>8</b> | <b>AUXILIARY LED LIGHT</b><br>860201229                              | <b>\$339.99</b> |
| <b>4</b> | <b>ERGO 2 STEP KNEE PADS</b><br>860201251                    | <b>\$89.99</b>  | <b>9</b> | <b>XC 356T6 CAST BUMPER</b><br>860201228                             | <b>\$289.99</b> |
| <b>5</b> | <b>FORWARD ADJUSTABLE RISER (FAR) EXTENSION</b><br>860201316 | <b>\$99.99</b>  |          |  |                 |

<b>LEVEL 1</b>	<b>ACCESSORIES COST</b>	<b>\$589.95</b>
	MONTHLY PAYMENT FOR 60 MONTHS†	\$11.65

<b>LEVEL 2</b>	<b>ACCESSORIES COST</b>	<b>\$1,524.91</b>
	MONTHLY PAYMENT FOR 60 MONTHS†	\$18.47

\*Certain conditions may apply. ©2016 Bombardier Recreational Products Inc. (BRP). All rights reserved. ®, ™ and the BRP logo are trademarks of BRP or its affiliates. All other trademarks are the property of their respective owners. In the U.S.A., products are distributed by BRP US Inc. Offers valid in U.S.A. only. The terms and conditions may vary depending on your state and these offers are subject to termination or change at any time without notice. Prices are based on Manufacturer Suggested Retail Price (MSRP) and are valid as of January 31, 2016. Dealers may sell for a different price. Taxes not included. †Monthly payments for 60 months: estimated with ANNUAL PERCENTAGE RATE at 6.9% for 60 months; for Tiers A - C customers only. ANNUAL PERCENTAGE RATES valid as of January 31, 2016 are subject to change. These financing programs are offered by Sheffield Financial, a Division of Branch Banking and Trust Company. Member FDIC. Subject to credit approval. Approval, and any rates and terms provided, are based on credit worthiness. Other financing offers are available. Rate advertised is based on minimum bureau risk score of 660. Minimum Amount Financed \$1,500; Maximum Amount Financed \$50,000. Other qualifications and restrictions may apply. Financing promotions void where prohibited. BRP is not responsible for any errors, changes or actions related to financing provided by Sheffield Financial. Down payment may be required. MSRP and monthly payments do not include the vehicle, pre-delivery inspection, installation, freight, taxes, title and registration fees. Your actual purchase price may be different due to rebates, promotions, fees and credit qualification. See an authorized BRP dealer for details. BRP reserves the right, at any time, to discontinue or change specifications, prices, designs, features, models, or equipment without incurring any obligations. Some models depicted may include optional equipment. Always consult your snowmobile dealer when selecting a snowmobile for your particular needs and carefully read and pay special attention to your Operator's Guide, Safety Video, Safety Handbook and to the safety labelling on your snowmobile. Always ride responsibly and safely. Always wear appropriate clothing, including a helmet. Always observe applicable local laws and regulations. Don't drink and drive. Printed in Canada.

# RENEGADE BACKCOUNTRY

OUR PROVEN ACCESSORIES. YOUR NEXT OFF-TRAIL ADVENTURE.



GET 1 YEAR FACTORY WARRANTY\* ON BRP ACCESSORIES. INSTALLED BY YOU OR YOUR DEALER.

- |          |  |                 |          |  |                 |
|----------|--|-----------------|----------|--|-----------------|
| <b>1</b> | <b>EXTREME SKID PLATE</b><br>860200741                       | <b>\$119.99</b> | <b>6</b> | <b>PILOT DS-2 SKIS (2X)</b><br>505073278 | <b>\$239.98</b> |
| <b>2</b> | <b>TRANSPARENT HANDLEBAR AIR DEFLECTORS</b><br>860200789     | <b>\$74.99</b>  | <b>7</b> | <b>GLOVEBOX EXTENSION</b><br>860200707   | <b>\$79.99</b>  |
| <b>3</b> | <b>ULTRA LOW WINDSHIELD</b><br>860200901                     | <b>\$94.99</b>  | <b>8</b> | <b>PREFILTER GRILLE KIT</b><br>860200610 | <b>\$104.99</b> |
| <b>4</b> | <b>WINDSHIELD BASE</b><br>860200956                          | <b>\$19.99</b>  | <b>9</b> | <b>SNOWFLAP</b><br>860200688             | <b>\$94.99</b>  |
| <b>5</b> | <b>LinQ PREMIUM TUNNEL BAG - SHORT 10 + 3 L</b><br>860200622 | <b>\$144.99</b> |          |  |                 |

<b>LEVEL 1</b>	<b>ACCESSORIES COST</b>	<b>\$454.95</b>
	MONTHLY PAYMENT FOR 60 MONTHS†	\$8.99

<b>LEVEL 2</b>	<b>ACCESSORIES COST</b>	<b>\$974.90</b>
	MONTHLY PAYMENT FOR 60 MONTHS†	\$10.27

\*Certain conditions may apply. ©2016 Bombardier Recreational Products Inc. (BRP). All rights reserved. ®, ™ and the BRP logo are trademarks of BRP or its affiliates. All other trademarks are the property of their respective owners. In the U.S.A., products are distributed by BRP US Inc. Offers valid in U.S.A. only. The terms and conditions may vary depending on your state and these offers are subject to termination or change at any time without notice. Prices are based on Manufacturer Suggested Retail Price (MSRP) and are valid as of January 31, 2016. Dealers may sell for a different price. Taxes not included. †Monthly payments for 60 months: estimated with ANNUAL PERCENTAGE RATE at 6.9% for 60 months; for Tiers A - C customers only. ANNUAL PERCENTAGE RATES valid as of January 31, 2016 are subject to change. These financing programs are offered by Sheffield Financial, a Division of Branch Banking and Trust Company. Member FDIC. Subject to credit approval. Approval, and any rates and terms provided, are based on credit worthiness. Other financing offers are available. Rate advertised is based on minimum bureau risk score of 660. Minimum Amount Financed \$1,500; Maximum Amount Financed \$50,000. Other qualifications and restrictions may apply. Financing promotions void where prohibited. BRP is not responsible for any errors, changes or actions related to financing provided by Sheffield Financial. Down payment may be required. MSRP and monthly payments do not include the vehicle, pre-delivery inspection, installation, freight, taxes, title and registration fees. Your actual purchase price may be different due to rebates, promotions, fees and credit qualification. See an authorized BRP dealer for details. BRP reserves the right, at any time, to discontinue or change specifications, prices, designs, features, models, or equipment without incurring any obligations. Some models depicted may include optional equipment. Always consult your snowmobile dealer when selecting a snowmobile for your particular needs and carefully read and pay special attention to your Operator's Guide, Safety Video, Safety Handbook and to the safety labelling on your snowmobile. Always ride responsibly and safely. Always wear appropriate clothing, including a helmet. Always observe applicable local laws and regulations. Don't drink and drive. Printed in Canada.

# RENEGADE ADRENALINE

OUR PERFECTLY INTEGRATED ACCESSORIES. YOUR NEXT AWESOME LONG WEEKEND.



GET 1 YEAR FACTORY WARRANTY\* ON BRP ACCESSORIES. INSTALLED BY YOU OR YOUR DEALER.

- |  |                 |   |                 |
|--|-----------------|---|-----------------|
| <b>1</b> AUXILIARY LED LIGHT<br>860201235                        | <b>\$339.99</b> | <b>6</b> FRONT BUMPER<br>860201170                            | <b>\$79.99</b>  |
| <b>2</b> SPORT PERFORMANCE FLARED WINDSHIELD - HIGH<br>860200602 | <b>\$134.99</b> | <b>7</b> REAR BUMPER<br>518326356                             | <b>\$79.99</b>  |
| <b>3</b> LinQ FUEL CADDY - 11 L<br>860200585                     | <b>\$129.99</b> | <b>8</b> ADJUSTABLE RISER FOR STRAIGHT HANDLEBAR<br>860201116 | <b>\$159.99</b> |
| <b>4</b> LinQ PREMIUM TUNNEL BAG - MEDIUM 19 + 3L<br>860200620   | <b>\$154.99</b> | <b>9</b> CHASSIS REINFORCEMENT KIT<br>860200816               | <b>\$69.99</b>  |
| <b>5</b> FULL BODY SKID PLATE<br>860201035                       | <b>\$129.99</b> |   |                 |

<b>LEVEL 1</b>	<b>ACCESSORIES COST</b>	<b>\$889.95</b>
	MONTHLY PAYMENT FOR 60 MONTHS*	\$17.58

<b>LEVEL 2</b>	<b>ACCESSORIES COST</b>	<b>\$1,279.91</b>
	MONTHLY PAYMENT FOR 60 MONTHS*	\$7.70

\*Certain conditions may apply. ©2016 Bombardier Recreational Products Inc. (BRP). All rights reserved. ®, ™ and the BRP logo are trademarks of BRP or its affiliates. All other trademarks are the property of their respective owners. In the U.S.A., products are distributed by BRP US Inc. Offers valid in U.S.A. only. The terms and conditions may vary depending on your state and these offers are subject to termination or change at any time without notice. Prices are based on Manufacturer Suggested Retail Price (MSRP) and are valid as of January 31, 2016. Dealers may sell for a different price. Taxes not included. \*Monthly payments for 60 months: estimated with ANNUAL PERCENTAGE RATE at 6.9% for 60 months; for Tiers A - C customers only. ANNUAL PERCENTAGE RATES valid as of January 31, 2016 are subject to change. These financing programs are offered by Sheffield Financial, a Division of Branch Banking and Trust Company, Member FDIC. Subject to credit approval. Approval, and any rates and terms provided, are based on credit worthiness. Other financing offers are available. Rate advertised is based on minimum bureau risk score of 660. Minimum Amount Financed \$1,500; Maximum Amount Financed \$50,000. Other qualifications and restrictions may apply. Financing promotions void where prohibited. BRP is not responsible for any errors, changes or actions related to financing provided by Sheffield Financial. Down payment may be required. MSRP and monthly payments do not include the vehicle, pre-delivery inspection, installation, freight, taxes, title and registration fees. Your actual purchase price may be different due to rebates, promotions, fees and credit qualification. See an authorized BRP dealer for details. BRP reserves the right, at any time, to discontinue or change specifications, prices, designs, features, models, or equipment without incurring any obligations. Some models depicted may include optional equipment. Always consult your snowmobile dealer when selecting a snowmobile for your particular needs and carefully read and pay special attention to your Operator's Guide, Safety Video, Safety Handbook and to the safety labelling on your snowmobile. Always ride responsibly and safely. Always wear appropriate clothing, including a helmet. Always observe applicable local laws and regulations. Don't drink and drive. Printed in Canada.

MATCHING YOUR WINDSHIELD TO CONDITIONS MADE EASY

## QUICK SWAP YOUR WINDSHIELD FOR COMFORT

Your sled's windshield contributes to the look and personality of your sled – but it's also the most important factor in your warmth and comfort. With today's riding gear technology and layering, we change our riding gear to match the variety of weather conditions we encounter snowmobiling. We've made it extremely easy to do the same thing with your sled's windshield.

In addition to the no-tool attachment system, where you merely plug the windshield into the rubber mounts, we offer a huge variety of windshield sizes, shapes and prices, so you'll find the ones that fit the riding conditions, your height and the look you want on your sled.



This medium injected windshield with side deflector kit is a popular choice. Once you've attached the side deflectors to the windshield support, changing from one windshield to another takes just a minute\*.

\*When using Medium and higher windshields, handguards must be removed.

### HERE'S HOW TO EASILY CHANGE FROM ONE WINDSHIELD TO ANOTHER:



**1**

Gently remove the current windshield, pulling at the base. Place and store it in an area where it won't get scratched.



**2**

Most larger windshields attach to the side of the hood for additional support. For those, remove the trim cover from each side of the hood. Be sure to keep these.



**3**

To install the new windshield, position it with these posts at each rubber mount and press with the heel of your hand until you hear and feel each attach securely. A light coating of grease or petroleum jelly makes this even easier. Attach the side deflectors or flares to the sides of the hood in the same fashion. That's it!



Stock Windshield MXZ X-RS



Low Windshield with Side Deflectors



Medium Windshield and Side Deflector Kit



# LinQ SYSTEM™

**FAST.  
EASY.  
SECURE.  
UNIQUE.**

This is the only accessory system that adapts quickly, easily and can easily transfer from sled-to-sled. It has become the most respected system for snowmobilers.



**NEW**  
**STACKABLE - 15 L  
LinQ FUEL CADDY**  
P. 133



**NEW**  
**SR 21 L LinQ TUNNEL BAG**  
P. 132



**NEW**  
**LinQ ERGO SUMMIT SEAT BAG**  
P. 136



**LinQ PREMIUM TUNNEL BAG - MEDIUM 19 + 3 L**  
P. 132



**LinQ PREMIUM TUNNEL BAG - SHORT 10 + 3 L**  
P. 132



**LinQ 1 + 1 COMPLETE SEAT SYSTEMS**  
P. 129-130



**LinQ 1 + 1 BACKREST**  
P. 130



**LinQ CARGO BOX - 40 L**  
P. 132



**SLIM TUNNEL BAG WITH LinQ SOFT STRAP**  
P. 135



**TUNNEL ROLL TOP BAG - MEDIUM 25 L WITH LinQ SOFT STRAP**  
P. 139



**LinQ SNOWBOARD/SKI RACK**  
P. 134



**LinQ FUEL CADDY - 11 L**  
P. 133



**LinQ SADDLEBAGS**  
P. 132



**LinQ REAR CARGO RACK**  
P. 141



**TUNNEL BACKPACK WITH LinQ SOFT STRAP**  
P. 135



# DESIGN BRIEF: SKI-DOO LinQ SYSTEM

In 2009, as the BRP team was developing the Can-Am ATV G2 platform, the design team turned their attention to the racking and cargo. As they observed riders using their ATVs in the real world, they saw all those bungee cords holding down cargo. And they saw the bungees stretch, the cargo bounce around, the bungees break and the hooks rust and fail. They decided there had to be a better way.

"We wanted a new attachment system that could attach accessories really quickly and solidly, and was versatile enough to be used with many different types of items, like racks, bags and fuel cans," said François Duval, design director of BRP's Lifestyle Studio. "We also understood owners would need to tie down odd-shaped items and even still use bungees. Our solution was the LinQ system, including special openings in the rack and LinQ clamps."

The LinQ clamp drops into the hex-shaped opening and a quarter-turn of its latch pulls the clamp tight and locks it in place. [Fun fact: LinQ stands for "Lock Integrated Quarter turn."] For added security, a tiny allen bolt can be screwed in to lock the latch in place.



The original LinQ logo, and the final one. The Q in the logo is designed to look like the LinQ latch.

With the design concept and architecture developed, the team turned to the implementation for snowmobiles.

"We had the openings molded into the composite racks on the Outlanders and SSVs and we considered something like that for sleds," recalls Duval. "But we have a very

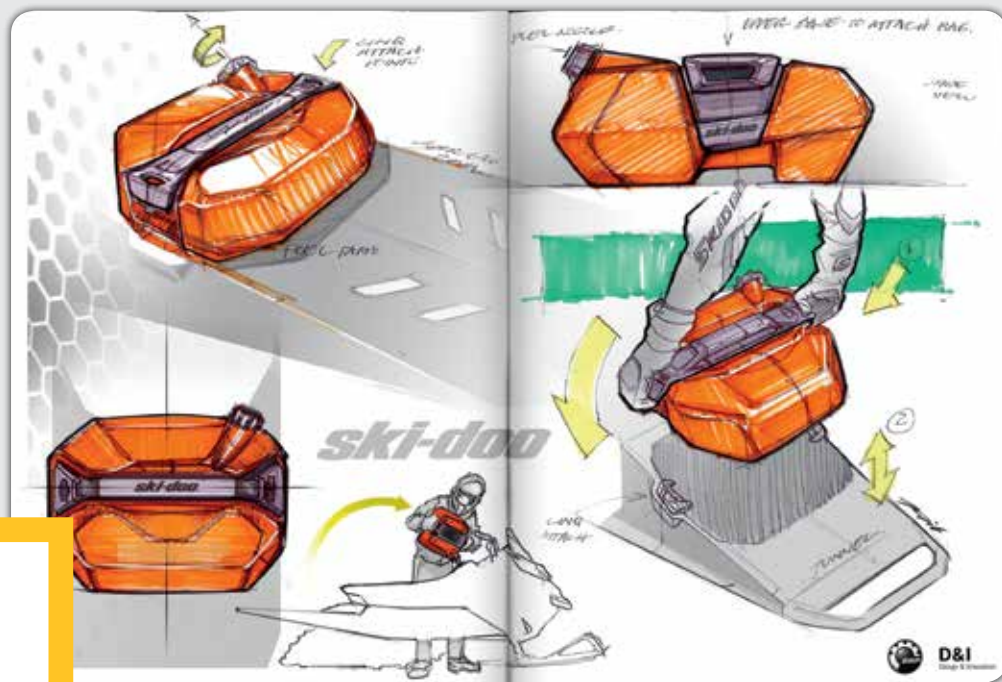

strong tunnel in the back, so we looked for a way to make the tunnel the base for the LinQ receivers. That's when we came up with the cleat and the bridges."

"It looks very simple, but that cleat does a lot of things," says Frederic Cossette, BRP Project Manager for Sea-Doo / Ski-Doo / Special Projects Accessories. "It's the base for the LinQ clamps. But it also receives the end of the bridge that goes over the heat exchanger [as a base for bags, boxes and fuel caddies] and holds the tabs for saddlebags and the snowboard / ski rack. And just like with the ATVs, you can use the cleats to strap your own things to the sled or our low profile tunnel bags. It's an amazing design."

**Of course, the devil was in the details and there were challenges getting the system just right.**

"While testing the devices in certain conditions we identified scenarios where the LinQ actually 'unLinQed,'" said Duval. "There were a few times in testing where we hit bumps and our LinQ bags went flying all over the trail. The force that faces an item at the

end of a sled tunnel can be up to 20 g when it hits a bump! So we kept refining how the latch and the bridge end connect, lock, how much pressure there is and the materials we used. And we did a lot of testing."

At BRP, accessories are part of the development process and with the REV-X platform, the tunnel was standardized to accommodate a 16" (40 cm) wide track and the mounting holes for the LinQ cleats were drilled into nearly every sled tunnel at the factory. This made installation take just minutes and ensured the cleats would be placed perfectly for every owner. An available base enables sleds with wide tracks to enjoy the benefits of any available Ski-Doo LinQ accessories.

New for 2017 is a new fuel caddy and tunnel bag, heavily influenced by snowmobiler feedback. The bags have a sleeker shape and drawstring liner to keep snowdust out. The fuel caddy is easier to pour and has bigger capacity (15 L). But the most exciting aspect is that the bag can be mounted on top of the Fuel Caddy, meaning a rider can now take extra fuel AND a LinQ bag on a short track sled.



TUNNEL BAG  
FUEL CADDY

## TWO SLEDS IN ONE : RENEGADE WITH ACCESSORIES

When we talk about offering accessories that take your snowmobile experience to the next level, this sled below is exactly what we mean. It's a sporty one-up mogul eating monster at heart... but **add just a few key accessories** and it's ready to take a passenger to enjoy winter with you. Everything's easy to install the first time. And it's super easy to go from one personality to another.



Stock Renegade



1. Glovebox Extension & Montana GPS  
2. Adjustable Riser for Straight Handlebar  
3. XC Bumper



1. Glovebox Extension & Montana GPS  
2. Adjustable Riser for Straight Handlebar  
3. XC Bumper  
4. Ultra High Windshield  
5. LinQ 1+1 Complete Seat System  
6. LinQ Premium Tunnel Bag  
7. Auxiliary LED Light

**NEW**  
WWW.SKI-DOO.COM



# BUILD YOUR DREAM SLED

ON THE NEW SKI-DOO.COM, WE'VE MADE IT EASIER THAN EVER TO CHOOSE THE ACCESSORIES THAT WILL MAKE YOUR 2017 SKI-DOO THE SNOWMOBILE YOU'VE ALWAYS DREAMED OF.



## Build your snowmobile

Like always, **choose** your model, feature package, engine, color and other factory options.



## Browse accessories

**Browse** the accessories you're interested in. You'll see larger images, item descriptions and prices.

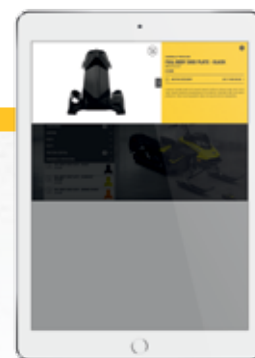

## Add it

Click to add this accessory to your built sled – it now appears on the snowmobile and in your accessories summary, so you can see just what it will look like. **Add or remove** accessories, change colors, at any time.

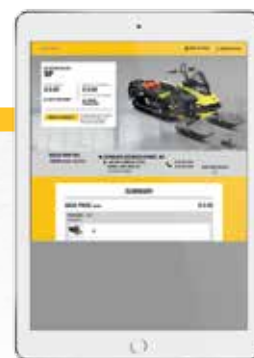

## Finish it

**Complete** your build. The vehicle summary includes your accessories in the price and monthly payment estimate. You can send this to your dealer and have them contact you, or print it and take with you for final negotiations and ordering.



## REV (G4)



**NEW**

### ULTRA HIGH WINDSHIELD KIT

- 26" (66 cm) in length.
- Provides maximum wind protection.
- Includes smoke side deflectors and support.
- Ready for Windshield-Mount Mirrors (860201285).

REV (G4)

860201260 • Clear

**\$199.99**



**NEW**

### MEDIUM WINDSHIELD KIT

- 17" (43 cm) in length.
- Offers a generous amount of protection with integrated style.
- Includes side deflectors and support.
- Ready for Windshield-Mount Mirrors (860201285).

REV (G4)

860201258 • Smoke

**\$139.99**



**NEW**

### LOW WINDSHIELD\*

- 14" (36 cm) in length.
- High quality, best durability.
- Includes low windshield support.
- Standard on REV platform 4<sup>th</sup> generation MXZ X.

REV (G4)

860201448 • Smoke

**\$119.99**

**NEW**

### WINDSHIELD SIDE DEFLECTOR KIT - LOW

- Increases wind deflection for windshields.

REV (G4)

For low and ultra low windshields

860201449 • Smoke

**\$29.99**



**NEW**

### WINDSHIELD SIDE DEFLECTOR KIT - MEDIUM

- Increases wind deflection for windshields.
- Ready for Windshield-Mount Mirrors (860201285).

REV (G4)

For medium and high windshields

860201256 • Smoke

**\$79.99**



\*Depending on your vehicle configuration, you may need corresponding windshield base kit and side deflectors to install this windshield. Ask your dealer for details.  
Note: When installing the windshield and/or windshield side deflectors on your vehicle, please make sure it does not - in any position - interfere with the operation of the steering and controls.



**REV-XS & REV-XM**



Without side deflectors



Shown with side deflectors (860201221), sold separately



**EXTRA HIGH WINDSHIELD\***

- 20" (51 cm) in length for extra protection.
- Standard on 2016-2017 Grand Touring.

**REV-XM, REV-XS**  
860201182 • Smoke  
**\$164.99**

- Side deflectors not included.

**SPORT PERFORMANCE FLARED WINDSHIELD - HIGH\***

- 16" (41 cm) in length.
- One-piece with integrated deflectors.
- Redirects snow in deep powder conditions.

**REV-XM, REV-XS**  
860200602 • Smoke  
**\$134.99**



**✓ DID YOU KNOW** All of the popular REV-XS accessories now work with 2016 and 2017 models equipped with the 1200 4-TEC engine.

**NEW**

**WINDSHIELD SUPPORTS**

- REV (G4)**  
For low windshields  
517305749 • Black  
**\$19.99**  
For medium windshields  
517306183 • Black  
For Summit  
517305875 • Black  
**\$24.99**

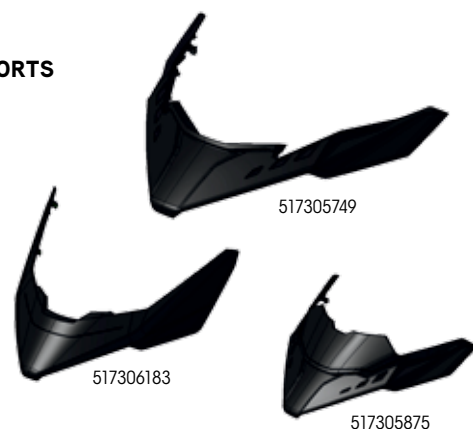

517305749

517306183

517305875

**NEW**

**WINDSHIELD-MOUNT MIRRORS**

- New mirror shape with an integrated look.
- Mounts on medium and higher windshield side deflectors and can be adjusted for 1-up or 2-up riding.

**REV (G4)**  
860201285  
**\$79.99**



**WINDSHIELD SIDE DEFLECTOR KIT**

- Adds lower body wind protection.
- Ready for Windshield Mirrors (860200694).
- Standard on 2016-2017 Grand Touring.

**REV-XM, REV-XS**  
For medium and higher windshields  
860201221 • Smoke  
**\$49.99**



**WINDSHIELD SIDE DEFLECTOR KIT**

- Increases wind deflection for windshields.
- Ready for Windshield Mirrors (860200694).

**REV-XM, REV-XS**  
For medium and higher windshields  
860200912 • Smoke  
**\$49.99**  
For low and ultra low windshields  
860201012 • Smoke  
**\$29.99**



\*Depending on your vehicle configuration, you may need corresponding windshield base kit and side deflectors to install this windshield. Ask your dealer for details.  
Note: When installing the windshield and/or windshield side deflectors on your vehicle, please make sure it does not - in any position - interfere with the operation of the steering and controls.



**REV-XS & REV-XM**



**LOW WINDSHIELD WITH GRAPHICS\***

- 9" (23 cm) in length.
- Injected windshield with embedded graphics.
- High quality, best durability.

REV-XM, REV-XS

860201087 • Black - Yellow Ski-Doo†

**\$119.99**



**ULTRA LOW WINDSHIELD\***

- 6" (15 cm) in length.

REV-XM, REV-XS

860200901 • Smoke

**\$94.99**



**MEDIUM INJECTED WINDSHIELD AND SIDE DEFLECTOR KIT**

- 13.5" (34 cm) in length.
- Offers a generous amount of protection with integrated style.
- Medium side deflectors ready to receive Windshield Mirrors (860200694).
- Includes medium windshield support.

REV-XM, REV-XS

860200759 • Smoke

**\$139.99**



**SPORT PERFORMANCE FLARED WINDSHIELD - MEDIUM\***

- 12" (31 cm) in length.
- One-piece with integrated deflectors.

REV-XM, REV-XS

860200696 • Smoke

**\$124.99**



**HIGH WINDSHIELD\***

- 18" (46 cm) in length.
- Side deflectors not included.

REV-XM, REV-XS

860200928 • Smoke

**\$154.99**



**ULTRA HIGH WINDSHIELD**

- Our largest sport windshield ever.
- 24" (60 cm) in length.
- One-piece with integrated deflectors.
- Maximum wind protection, for extreme cold conditions.
- Ready to receive Windshield-Mount Mirrors (860200103).

REV-XM, REV-XS

860201185 • Clear

**\$184.99**

**REV-XS & REV-XM**



**POWDER PLOW®\* FOR WINDSHIELD**

- Specifically designed for deep snow powder deflection.
- Deflects snow to sides instead of towards driver's face.
- Easily attaches underneath windshield support.
- Can be installed with or without REV-XM, REV-XS low, and ultra low windshield.

REV-XM & REV-XS with low, extra low or without windshield

860200603 • Black†

**\$124.99**

The Powder Plow diverts the snow away from the center of the vehicle, keeping the rider drier and increasing overall visibility.



**WINDSHIELD BASE**

- Colored plastic trim.
- Hardware not included.

REV-XM, REV-XS

Ultra low, low and one-piece windshields

- 517305403 • Grey
- 517305617 • Manta Green
- 517305808 • Sunburst Yellow
- 517305948 • Lava Red
- 517305952 • White

**\$24.99**

- 860200937 • Black
- 860200956 • Yellow

**\$19.99**

Medium and high windshields

- 860200944 • Black
- 860200957 • Yellow

**\$24.99**



**REV-XP**



**ULTRA LOW FIXED WINDSHIELD\***

- 6" (15 cm) in length.

REV-XP

860200646 • Smoke with X graphic

**\$104.99**



**LOW WINDSHIELD AND SIDE DEFLECTOR KIT**

- 12" (30 cm) in length.
- Same complete kit as found on the 2011-2012 X package models.
- Retrofittable on earlier REV-XP snowmobile models.
- Includes low windshield, side deflector and base kit.

REV-XP

860200545 • Smoke

**\$104.99**



**MEDIUM WINDSHIELD KIT**

- Includes medium injected windshield, dark smoke side deflector kit and base kit.

REV-XP

860200478 • Smoke

**\$139.99**



**WINDSHIELD SIDE DEFLECTOR KIT**

- Increased wind deflection for windshields.

REV-XP - Medium & High

860200084 • Dark Smoke

**\$39.99**



**SPORT PERFORMANCE FLARED WINDSHIELD**

- 17 1/2" (44.5 cm) in length.
- One piece with integrated side deflectors.
- Complete with base mounting kit.

REV-XP

860200547 • Smoke

**\$124.99**



**ULTRA HIGH WINDSHIELD\***

- 23" (58 cm) in length.
- Note: J-hooks need to be removed to install windshield.

REV-XP

860200225 • Clear with fading

**\$124.99**



**WINDSHIELD BASE KIT**

- Plastic trim for windshields.

REV-XP - Medium, High & Ultra High

860200091 • Black

**\$24.99**

REV-XP - Ultra Low & Low

860200089 • Black

**\$19.99**

†While supplies last.

\*Depending on your vehicle configuration, you may need corresponding windshield base kit and side deflectors to install this windshield. Ask your dealer for details.

Note: When installing the windshield and/or windshield side deflectors on your vehicle, please make sure it does not - in any position - interfere with the operation of the steering and controls.

†While supplies last.

\*Depending on your vehicle configuration, you may need corresponding windshield base kit to install this windshield. Ask your dealer for details.

Note: When installing the windshield and/or windshield side deflectors on your vehicle, please make sure it does not - in any position - interfere with the operation of the steering and controls.



**REV-XR & REV-XU**



860200438

860200453

**SPORT PERFORMANCE FLARED WINDSHIELD**

- One-piece with integrated side deflectors.
- Top flare maximizes wind protection and redirects snow in deep powder conditions.
- Complete with base mounting kit.

REV-XR, REV-XU - High 17 1/2" (44.5 cm)

860200438 • Smoke

**\$124.99**

REV-XR, REV-XU - Medium 14" (35.6 cm)

860200453 • Smoke

**\$124.99**



**EXTRA HIGH ONE-PIECE WINDSHIELD**

- 23" (58 cm) in length.
- One-piece with integrated deflectors.
- Maximum wind protection.
- For extreme cold conditions.
- Ready to receive Windshield-Mount Mirrors (517305787).
- No windshield base required.

REV-XR, REV-XU

860201000 • Clear

**\$154.99**



**ULTRA HIGH WINDSHIELD\***

- 27 1/2" (70 cm) in length.
- REV-XR, REV-XU, except MXZ and Renegade with J-hooks

860200227 • Clear with fading

**\$124.99**

**WINDSHIELD SIDE DEFLECTOR KIT**

- Increased wind deflection for windshields.

REV-XR, REV-XU  
Fits extra high and ultra high windshields using base kit (860200230)

860200235 • Smoke

**\$49.99**

REV-XR, REV-XU  
Fits medium and high windshields using base kits (860200229)

860200234 • Smoke

**\$39.99**



**LATERAL AIR DEFLECTOR KIT**

- Added wind protection.

REV-XU WT, SWT, Expedition SE, LE, Xtreme

860201039 • Black

**\$64.99**



**KNEE AIR DEFLECTORS**

- Redirect the wind away from your knees while adding a finishing touch to your sled.
- Sold in pairs.

REV-XP

860200087 • Black

**\$23.99**



**WINDSHIELD BASE KIT**

- Colored plastic trim.

REV-XR, REV-XU

Low

860200228 • Black

**\$19.99**

Medium & High

860200229 • Black

**\$24.99**

Extra High & Ultra High

860200230 • Black

**\$24.99**



**PIVOTING MIRROR KIT FOR HANDLEBAR AIR DEFLECTORS**

- Perfectly integrated design and style.
- Mirrors fold away when not in use for easy storage or when covering vehicle.
- Sold in pairs.

Vehicles with Transparent Handlebar Air Deflectors

860200893 • Black

**\$34.99**



**WINDSHIELD-MOUNT MIRRORS**

- Windshield mount design.
- 3" round reflector with adjustable angle.

REV-XU, REV-XR (with extra high one-piece windshield)

517305787 • Black

**\$39.99**



**HANDLEBAR AIR DEFLECTOR MIRROR KIT**

- Handlebar mount air deflector.
- Sold in pairs.

Vehicles with 2011 and up Handlebar Air Deflectors

860200674 • Black

**\$24.99**

Our Handlebar Air Deflector Mirrors pivot out of the way when you want a sleek look or are covering your sled.

**MIRROR KITS**



- Side panel mount design.
- Sold in pairs.
- Premarked side panels make installation easier.

REV-XM, REV-XS (except 1200)

860200607

**\$79.99**



- Side panel body mount design.
- Sold in pairs.

REV-XP, REV-XR, REV-XU Tundra

860200693

**\$69.99**



- Windshield extension mount design.
- Sold in pairs.

REV-XM, REV-XS, REV-XP, REV-XR, REV-XU (with medium and higher windshield side deflectors)

860200694

**\$59.99**



- Windshield mount design.
- Sold in pairs.

REV-XS, REV-XM (with ultra high windshield)

860200103

**\$39.99**



- Handlebar wind deflector mount design.
- Sold in pairs.

Vehicles with 2010 & prior Handlebar Air Deflectors

860200080

**\$24.99**

\*Depending on your vehicle configuration, you may need corresponding windshield base kit to install this windshield. Ask your dealer for details.  
Note: When installing the windshield and/or windshield side deflectors on your vehicle, please make sure it does not - in any position - interfere with the operation of the steering and controls.

**TRANSPARENT HANDLEBAR AIR DEFLECTORS**

- Design delivers better protection and great style.
- Comes with black/grey colored interchangeable caps.
- Use with low and ultra low windshield - for all handlebars.
- Sold in pairs.

REV (G4), REV-XS, REV-XM, REV-XP, REV-XR, REV-XU

860200789 • Grey/Black

**\$74.99**

**NEW**

- Featuring new more flexible mounts for extreme conditions.

860201254 • Grey/Black

**\$89.99**

**HANDLEBAR AIR DEFLECTORS EXTENSION KIT**

- Semi-rigid, won't collapse at high speed.
- Delivers additional hand protection from the elements.
- Can be installed and removed in seconds.

Vehicles with Transparent Handlebar Air Deflectors

860200781 • Black

**\$74.99**

**HANDLEBAR AIR DEFLECTORS CAPS**

- Colored caps let you customize your look.
- Sold in pairs.

Vehicle with Transparent Handlebar Air Deflectors

860201344 • Sunburst Yellow/Black  
 860201345 • Race Orange/Black  
 860201347 • White/Black  
 860201346 • Black/Grey

**\$39.99**

**NEW**

860201457 • Orange Crush/Black

**\$39.99**

**HANDLEBAR MUFFS**

- Ultra warm handlebar muffs with fleece liner.
- Designed for extreme cold conditions.
- Easy to remove in warmer weather.
- Can be used on handlebars with or without handguards and mirrors.

Does not fit vehicles with large handlebar pad. Fits with Handlebar Air Deflectors 2015 and up

860201144 • Black

**\$59.99**

- Inner skeleton allows muff to keep its shape and gives more space for hand movement.
- Transparent section allows visibility and easy manipulation of control switches.
- Note: Never use handlebar muffs with finger throttle lever.



**NEW**

**AUXILIARY LED LIGHT**

- New dynamic scoop design integrates perfectly with 4th generation REV platform.
- 8 LED lamps provide more than 2,500 additional lumens for an intense super-wide foglight-type pattern.
- Say goodbye to sacrificing close range lighting when switching to high beams.
- Easily installs on hood with a simple plug-and-play hook-up.

REV (G4)

860201229

**\$339.99**

**NEW**

**AUXILIARY LED LIGHT**

- 10 LED lamps provide more than 2100 additional lumens in an intense, super-wide foglight-type pattern.
- Three-position OFF-ON-HI switch gives you the option of riding with these lights off, always on or only when switching to your high beams.
- Say goodbye to sacrificing close range lighting when switching to high beams.
- Easily installs below stock headlight with a simple plug-and-play hook-up.

REV-XM, REV-XS, except Expedition Sport

860201235

**\$339.99**



▶ See the dramatic effect this Auxiliary LED Light generate. [www.ski-doo.com/genuine-parts-accessories-riding-gear/catalog-video](http://www.ski-doo.com/genuine-parts-accessories-riding-gear/catalog-video)



▶ These signature handguard lights create a nighttime look unlike anything on the market.

**NEW**

**SIGNATURE LED LIGHT FOR HANDLEBAR AIR DEFLECTORS**

- Delivers a unique look at night.
- Replaces stock handguard cap with LED light.
- Includes wiring harness.
- Sold in pairs.

REV-XM, REV-XS with Transparent Handlebar Air Deflectors. Can be installed on REV-XP, REV-XR, REV-XU with Adaptor for Signature LED Light for Handlebar Air Deflectors (860201114)

860200981 • Black

**\$119.99**

**NEW**

REV (G4) with Transparent Handlebar Air Deflectors

860201406 • Black

**\$124.99**

▶ A first in snowmobiling, creates a signature look at night.



▶ See the dramatic effect these Handlebar Air Deflector generate. [www.ski-doo.com/genuine-parts-accessories-riding-gear/catalog-video](http://www.ski-doo.com/genuine-parts-accessories-riding-gear/catalog-video)

Note: When installing steering / handlebar accessories, make sure windshield and deflectors do not interfere - in any position - with the operation of the steering and brake lever.



**ADJUSTABLE RISERS**

- Instantly modify your handlebar height to adapt to changing riding conditions.
- Utilize the lower position for trail / sit down riding; extend to maximum height in seconds for stand up riding.
- No tools required to make the adjustment, just flip the lever.
- Patent pending US20150360713A1.



**ADJUSTABLE RISER FOR STRAIGHT HANDLEBAR (XS-XM-XP)**

- Adjustable length: 5.1" to 8" (130 mm to 205 mm) high.
- Works with all stock cables and wiring.

**Fits Renegade Backcountry (2011 and up) with 6.3" (160 mm) riser block**

**860200634 • Black/Aluminum**

- Adjustable length: 4.7" to 6.3" (120 mm to 160 mm) high.
- Works with all stock cables and wiring.

**Fits MXZ and Renegade with 4.5" (115 mm) or 5.1" (130 mm) stock riser 2013 and up. Requires steering pad (506152541) for MXZ and Renegade X-RS**

**860201116 • Black/Aluminum**

- Adjustable length: 7.3" to 9.8" (185 mm to 250 mm) high.
- Works with all stock cables and wiring.

**Fits Summit SP, REV-XU Skandic - Vehicles with 8" (205 mm) riser block**

**860200972 • Black/Aluminum**

**\$159.99**

**ADJUSTABLE RISER FOR TAPERED HANDLEBAR (XM-XP)**

(Not illustrated)

- Adjustable length: 4.5" to 6.9" (115 mm to 175 mm) high.
- Works with all stock cables and wiring.
- For REV-XP platform; requires steering pad (506152717) (not included).

**Summit X & Freeride\* - Vehicles with 5.1" (130 mm) riser block**

**860200973 • Black/Aluminum**

**\$164.99**

\*Brake line (507032535) required for Freeride 2011 only. To be ordered separately.  
\*\*Except MXZ models



860201429

860201276



860201116

860200972

Adjusting riser height is easy as flipping a lever. Check it out. [www.ski-doo.com/genuine-parts-accessories-riding-gear/catalog-video](http://www.ski-doo.com/genuine-parts-accessories-riding-gear/catalog-video)

**NEW**

**ADJUSTABLE RISER FOR STRAIGHT HANDLEBAR (REV (G4))**

- Adjustable length: 4.9" to 6.3" (125 mm to 160 mm) high.
- Works with all stock cables and wiring.
- **MXZ and Renegade with 4.7" (120 mm) riser block**
- **860201429**
- **Black/Aluminum**
- **\$159.99**
- Adjustable length: 6.9" to 9.3" (175 mm to 235 mm) high.
- Works with all stock cables and wiring.
- **Summit with 7.5" (190 mm) riser block**
- **860201276**
- **Black/Aluminum**
- **\$164.99**



**NEW**

**FORWARD ADJUSTABLE RISER (FAR) EXTENSION**

- Raises by 1.8" (45 mm) the height of the forward adjustable riser on the REV platform 4<sup>th</sup> generation.

**REV (G4)**

**860201316**

**\$99.99**

**NEW**

**FORWARD ADJUSTABLE RISER (FAR)**

- Tool-less customization of the riding position in seconds.
- 4 positions over 4" (10 cm) of fore-aft adjustment.
- Standard on REV platform 4<sup>th</sup> generation X packages.

**REV (G4) MXZ and Renegade**

**860201320**

**\$99.99**



**NEW**

**EXTENSION KIT FOR STRAIGHT HANDLEBAR**

- Handlebar extension kit to fit all riding styles.

**Fits REV (G4) MXZ and Renegade with 4.7" (120 mm) riser block**

**860201393 • 6.5" (165 mm)**

**\$89.99**

**860201427 • 4.7" (120 mm)**

**\$59.99**

**Fits REV (G4) Summit with 7.5" (190 mm) riser block**

• Works with all stock wiring and cables.

**860201392 • 9.3" (235 mm)**

**\$99.99**

**860201428 • 7.5" (190 mm)**

**\$59.99**



860201393

860201427

860201392

860201428

**EXTENSION KIT FOR STRAIGHT HANDLEBAR**

- Handlebar extension kit to fit all riding styles.
- Works with all stock wiring and cables.

**REV-XS, REV-XR, REV-XP, REV-XU Tundra**

**860200819 • MXZ 4.5" (115 mm)**

**\$54.99**

**Fits Renegade Backcountry (2011 and up) with 6.3" (160 mm) riser block**

**860200821 • 8" (205 mm)**

**Fits Summit SP, REV-XU Skandic - Vehicles with 8" (205 mm) riser block**

**860200822 • 9.8" (250 mm)**

**REV-XS, REV-XR, REV-XP, REV-XU Tundra**

**860200820 • MXZ 6.3" (160 mm)**

**\$64.99**



**EXTENSION KIT FOR TAPERED HANDLEBAR**

- 6.9" (175 mm) extension.
- 1.8" (45 mm) higher than stock extension.
- Works with all stock wiring and cables (except Freeride 2011\*).

**Summit X & Freeride - Vehicles with 5.1" (130 mm) riser block**

**860200758 • Black**

**\$74.99**



\*Brake line (507032535) required for Freeride 2011 only. To be ordered separately.



## REV (G4)



**NEW**

### FULL BODY SKID PLATE

- Injection molded process provides smooth surface, better definition, a perfect fit and easier installation.
- For assertive riders who demand the utmost protection.
- 4 mm thick high impact resistance polypropylene for durability.

- Extra wide, covers vital primary clutch, chaincase and front heat exchanger components to provide maximum underbelly protection.
- Chassis is premarked for easy installation.
- New mounting system.
- Attachment kit included.

#### REV (G4)

860201227 • Black  
860201441 • Sunburst Yellow

860201442 • Orange Crush  
860201443 • White

**\$129.99**



## REV-XU EXPEDITION

### FULL BODY SKID PLATE

- Provides additional underbelly protection in off trail conditions.
- Made of high molecular weight polyethylene.
- Helps glide on snow and prevents snow from sticking to the frame.
- Works with A-arm protectors.
- Standard on REV-XU Expedition SE.

REV-XU Expedition SE, Xtreme, LE 2009 and up

860200563 • Black

**\$159.99**



### REAR SKID PLATE

- Extra underbelly protection.
- Protects components such as brakes and gearbox from impacts.
- High molecular weight polyethylene.
- Can be combined with Full Body Skid Plate (860200563) for maximum protection.

REV-XU Expedition SE, Xtreme, LE

860201361 • Black

**\$139.99**



## REV-XP/REV-XR

### FULL BODY SKID PLATE

- High molecular weight polyethylene embossed with Ski-Doo logo.
- For assertive riders who demand the utmost protection.
- Attachment kit included.
- Chassis is premarked for easy installation.

#### REV-XP

860200203 • White<sup>‡</sup>  
860200287 • Black

#### REV-XR

860200167 • Black

**\$109.99**



## REV-XM & REV-XS

### HIGH PERFORMANCE SKID PLATES

- Injection molded process provides smooth surface, better definition, a perfect fit and easier installation.
- For assertive riders who demand the utmost protection.
- Smooth bottom surface to reduce drag.
- 4 mm thick high impact resistance polypropylene for durability.
- Extra wide, covers vital primary clutch, chaincase and front heat exchanger components to provide maximum underbelly protection.
- Attachment kit included.
- Chassis is premarked for easy installation.
- Includes marking for 4-stroke oil change cut-out.



### FULL BODY SKID PLATE

- Wide shape for full protection and maximum flotation.

#### REV-XM, REV XS

860201034 • Lava Red  
860201035 • White  
860200605 • Black  
860200739 • Yellow

860200740 • Orange Crush  
860201147 • Manta Green  
860201148 • Sunburst Yellow

**\$129.99**



### EXTREME SKID PLATE

- Relieved A-arm area that reduces chance of snow buildup.

#### REV-XM, REV XS

860201032 • Lava Red  
860201033 • White  
860200606 • Black  
860200741 • Yellow  
860200742 • Orange Crush

860201145 • Manta Green  
860201146 • Sunburst Yellow

**\$124.99**

**\$119.99**

## REV-XU SKANDIC

### FULL BODY SKID PLATE

- High molecular weight polyethylene.
- Provides maximum underbelly protection in off trail conditions.
- Helps glide on snow and prevents snow from sticking to the frame.

REV-XU WT 2015 and prior

860200702 • Black

REV-XU WT 2016 and up

860201342 • Black

**\$204.99**

REV-XU SWT 2015 and prior

860200713 • Black

REV-XU SWT 2016 and up

860201343 • Black

**\$234.99**



## SNOWFLAPS

- Customize your sled.
- Hardware included.

#### REV-XM

860200689 • White/Black  
860201038 • Lava Red/White  
REV-XS 129" & 137"

860200765 • White/Black

**\$94.99**



860200689



860201038

## REV-XU TUNDRA

### FULL BODY SKID PLATE

- High molecular weight polyethylene.
- Provides maximum underbelly protection in off trail conditions.
- Helps glide on snow and prevents snow from sticking to the frame.

REV-XU Tundra

860200601 • Black

**\$169.99**



REV-XP, REV-XR except GTX, Grand Touring, REV-XU Expedition 2009 and up

860200106 • Black/Yellow  
860200467 • Black/Gray

**\$74.99**



860200106

**DID YOU KNOW** These injection molded skid plates fit precisely and their smooth bottom surface slides easily through snow.

<sup>‡</sup>White supplies last.



**NEW**

**HEAVY-DUTY REAR BUMPER**

- Premium finish heavy-duty aluminum bumper for REV platform 4<sup>th</sup> generation.
- Doesn't detract from deep snow performance.
- Required for LinQ Snowboard / Ski Rack (860201255).
- Easy attachment with no cutting or drilling.

REV (G4)  
 860201369 • Black 154"      860201431 • Black 165"  
**\$249.99**                      **\$249.99**



**NEW**

**HITCH REAR BUMPER**

- Premium finish heavy-duty bumper for hitch applications for REV platform 4<sup>th</sup> generation.
- Required for hitch use.
- Easy attachment with no cutting or drilling.

REV (G4)  
 860201433 • Black 129"      860201250 • Black 154"  
 860201471 • Black 137"      **\$94.99**  
**\$89.99**                      860201424 • Black 165"  
**\$99.99**



**NEW**

**FRONT BUMPER**

- Easy-install bumper changes the appearance of your sled in minutes.

REV (G4)  
 502007460 • Black  
 860201445 • White  
**\$79.99**



**NEW**

**REAR BUMPER**

- Easy-install bumper changes the appearance of your sled in minutes.

REV (G4)  
 129"                      154"                      165"  
 518329151 • White      518329152 • White      518329153 • White  
 518328745 • Black      518328501 • Black      518328697 • Black  
**\$79.99**                      **\$89.99**                      **\$89.99**



**NEW**

**XC 356T6 CAST BUMPER**

- Add extra protection and attitude with this bumper.
- Perfect integration with or without a skid plate.
- Lightweight cast aluminum heat treated construction.

REV (G4)  
 860201228  
**\$289.99**

**FRONT BUMPER**

- Easy-install bumper changes the appearance of your sled in minutes.

**REV-XM, REV-XS**

860201167 • Black  
 860201168 • Orange Crush  
 860201170 • White  
 860201171 • Lava Red  
 860201172 • Fusion Red  
 860201173 • Manta Green  
 860201174 • Race Orange  
 860201175 • Sunburst Yellow

**REV-XP**

502007116 • Black  
**\$79.99**



**REAR BUMPER**

- Easy-install bumper changes the appearance of your sled in minutes.

**REV-XP, REV-XR, REV-XS**

(120" - 137")  
 518325481 • Black  
 518328678 • Sunburst Yellow  
**\$79.99**



**EXTRA BUMPER**

- Heavy-duty front bumper.

**REV-XU Expedition**

860200350 • Black  
**\$209.99**



**HITCH REAR BUMPER**

- Heavy-duty aluminum bumper for hitch applications.
- Easy attachment with no cutting or drilling.
- Does not fit Grand Touring SE, LE.

**REV-XP, REV-XM**

860200953 • Black 146"  
 860200954 • Black 154"  
 860200955 • Black 163"  
**\$89.99**

860201135 • Black 174"  
**\$134.99**

860200952 • Black 120" - 137"  
**\$79.99**

**REV-XU Tundra, REV-XS, REV-XP,**

**REV-XR - 120" - 137" Does not fit on Freeride 137"**  
 860200803 • Aluminium 120" - 137"  
**\$69.99**

**REV-XS MXZ 129"**  
 860201306 • Black 129"  
**Renegade X-RS, Freeride**  
 860201307 • Black 137"  
**\$79.99**



**XC BUMPER**

- The ultimate front protection for your sled, providing additional front and lateral protection.
- Large center grab area for additional leverage.
- Heavy-duty performance with lightweight aluminum construction.

**REV-XM, REV-XS**

860201099 • Aluminum  
 860201318 • Black  
**\$229.99**



**FULL WRAP-AROUND BUMPER**

- Full 1.25" (3.8 cm) diameter heavy-duty steel wrap-around model.
- Delivers added protection to front of sled and side panels.
- Attaches to existing bumper and footrests.

**REV-XU Tundra**

860200572 • Black  
**\$229.99**

**HITCH TONGUE**

- Easily transforms the C-type Hitch (860200829) into a tongue-type hitch.

511000521 • Black  
**\$11.99**



**C-TYPE HITCH**

- Heavy-duty C-type hitch works in conjunction with heavy-duty bumpers.

**REV-XP, REV-XR, REV-XU Tundra, REV-XS, REV-XM**

860200829 • Black  
**\$49.99**



**TONGUE TYPE HITCH**

- Heavy-duty tongue type hitch works in conjunction with heavy-duty bumpers.

**REV-XP, REV-XR, REV-XU Tundra, REV-XS, REV-XM**

860200902 • Black  
**\$49.99**



‡While supplies last.



**XU REAR HEAVY-DUTY BUMPER**

- Ready to accept 2" Receiver (860201062).
- Essential for modular towing options.
- Provides complete rear protection.
- Works hard during intense use.
- Features convenient hand-gripping area.

Skandic SWT  
860201106 • Black  
**\$309.99**

Skandic WT, Expedition SE, LE  
860200991 • Black  
**\$289.99**



**HEAVY-DUTY FRONT BUMPER WITH 2" RECEIVER**

- Increases front protection.
- Integrated 2" Multi-Mount Receiver.
- Works with 2" Multi-Mount Drawbar (860201117) and Multi-Mount Winch (860200992).
- Note: Not compatible with Prefilter Grille Kit (860201152).

Skandic WT, SWT  
860200987 • Black  
**\$309.99**

▶ See the Utility Accessories.  
[www.ski-doo.com/genuine-parts-accessories-riding-gear/catalog-video](http://www.ski-doo.com/genuine-parts-accessories-riding-gear/catalog-video)

**HEAVY-DUTY TONGUE HITCH**

- Cast stainless steel construction.
- Mounting pattern for Heavy-duty bumpers and Multi-Mount Drawbar (860201117).

Fits directly on: Skandic WT, SWT, Expedition SE, LE).  
Fits on XU Rear Heavy-Duty Bumpers WT (860200991) or SWT (860201106).  
Fits on Multi-Mount Drawbar (860201117)  
860201023 • Stainless Steel  
**\$59.99**



**2" RECEIVER FOR HEAVY-DUTY REAR BUMPER**

- Easy installation.
- Standard 2" size for wide compatibility.
- Allows quick switching of towing hook-ups or winch use.
- Note: Does not fit with stock tongue hitch 2016-2017.

Fits on XU Rear Heavy-Duty Bumpers WT (860200991) or SWT (860201106)  
860201062 • Black  
**\$79.99**



**EXTRA FRONT BUMPER**

- Made of heavy duty high-strength steel to protect front and side of body.

REV-XU WT, SWT  
860200561 • Black  
**\$279.99**



**MULTI-MOUNT DRAWBAR**

- Allows quick installation and removal of different towing platforms.
- Compatible with J-Hitch (860201142) and Heavy-Duty Tongue Hitch (860201023).

Fits on XU Rear 2" Receiver for Heavy-Duty Bumper (860201062) and XU Front Bumper with 2" Receiver (860200987)  
860201117 • Black  
**\$104.99**



**FRONT & REAR HITCH DRAWBAR**

- Fits 2" receiver hitch.
- Hitch ball not included.

Fits on XU Rear 2" Receiver for Heavy-Duty Bumper (860201062) and XU Front Bumper with 2" Receiver (860200987).  
715000972 • Black  
**\$79.99**



**J-HITCH**

- Spring-loaded latch system for quick, secure hook up.

Fits directly on: Skandic WT, SWT, Expedition SE, LE, Xtreme. Fits on XU Rear Heavy-Duty Bumpers WT (860200991) or SWT (860201106). Fits on Multi-Mount Drawbar (860201117)  
860201142 • Black  
**\$69.99**



# FREEDOM FOR YOUR FEET

The new 4th Generation REV platform sets your feet free — free to work with the sled how YOU want. MXZ, Renegade and Summit sleds each come with foot areas specialized for the riding style — MXZ and Renegade sleds with open toe-holds, Summit sleds with a mountain toe hook.

## WITH NEW ACCESSORIES, YOU CAN CUSTOMIZE YOUR FOOT AREA FOR HOW YOU RIDE:

**DO YOU PUSH OUTWARD WITH YOUR FEET WHEN CORNERING?**

- 1 Add the **Ergo Lateral Footplates** for added leverage and comfort.

**LIKE THE FREEDOM TO PIVOT YOUR FEET WITH THE OPEN TOE-HOLDS, BUT WANT A TIGHTER FIT FOR THE TOP OF YOUR BOOT?**

- 2 Install the **Ergo Shim Kit** (both 10 mm and 20 mm shims are included).

**WANT A FULLY LOCKED-IN IN FEEL AND FIT?**

- 1 Use the **Ergo Lateral + Footplates** and the
- 2 **Ergo Shim Kit** to keep those boots snug.

The Ergo Adjustable Toe-Holds are a totally new experience for mountain riders. They add leverage when you want it and they easily adjust up, down, forward and back for a custom fit. They're also spring-loaded folding — they fold downward when weight is applied from the top — to stay out of the way when shifting from side to side.



## FINALLY. CUSTOM FIT FOR HOW YOU RIDE WITH ERGO COMPONENTS

1 Ergo 2 Step Knee Pads

2 Ergo Shim Kit for Toe-Hold

**NEW**

### ERGO 2 STEP KNEE PADS

- Designed for a perfect fit on the REV platform 4<sup>th</sup> generation MXZ Ergo-Step side panels to allow easy transition to both stages of the panel.
- Provide comfort and impact absorption.
- Provide extra knee grip.
- Injected molded soft material.
- Easy install with peel-off adhesive.

REV (G4) MXZ and Renegade

860201251

**\$89.99**



**NEW**

### ERGO KNEE PADS

- Designed for a perfect fit on the REV platform 4<sup>th</sup> generation Summit side panels.
- Provide comfort and impact absorption especially on steep descents.
- Provide extra knee grip.
- Injected molded soft material.
- Easy install with peel-off adhesive.

REV (G4) Summit (with electric start)

860201363

**\$69.99**



**NEW**

### ERGO ADJUSTABLE TOE-HOLDS

- Die-cast aluminum part.
- Allow user to adjust toe-hold position for different riding styles and control.
- Foldable to ease floorboard access.
- Adjustable 3" (7.6 cm) rearward and 1.5" (3.8 cm) upward.
- Forward/backward and top/down adjustments.

REV (G4) Summit

860201370

**\$229.99**



**NEW**

### ERGO SHIM KIT FOR TOE-HOLDS

- Fit your REV platform 4<sup>th</sup> generation MXZ and Renegade to your size or style.
- Spacers in two heights (10 & 20 mm) let you determine how tight your boots fit the toe-holds.

REV (G4) MXZ

860201408

**\$49.99**



### CHASSIS REINFORCEMENT KIT

- Provides additional reinforcement to your tunnel along with improved grip.
- Easy installation.
- Does not fit Grand Touring.

REV-XS (except Renegade Backcountry/Backcountry X),

REV-XP, REV-XR, REV-XU Tundra (except 2015 and up)

860200521 • Viper Red

860200814 • Black

860200815 • Yellow

860200816 • White

**\$69.99**

860200813 • Aluminum

**\$59.99**

860201030 • Lava Red

860201031 • Orange Crush

860201150 • Fusion Red

860201151 • Sunburst Yellow

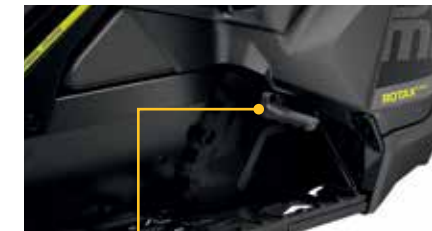

**NEW**

### ERGO FIXED TOE-HOLDS

- Fixed toe-holds for control and leverage when boondocking.

REV (G4) Summit

860201510 • Aluminum

**\$79.99**

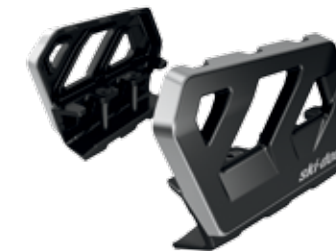

**NEW**

### ERGO LATERAL FOOTPLATES

- Cast aluminum outer support for riders that use their feet to push in corners, or desire a more locked in feel.

REV (G4)

860201402

**\$99.99**



### TUNNEL GRIP PLATES

- Lightweight plastic grip plates for extra side boot grip in rough riding conditions.
- Developed for the 600 Race sled.
- Sold in pairs with complete hardware.

REV-XP, REV-XR, REV-XS, REV-XM, REV-XU Tundra

860200164

**\$34.99**



### SUMMIT RAIL REINFORCEMENT

- Increases rail strength and longevity.

REV-XM 174"

860201218 • Black

**\$74.99**

REV-XP & REV-XM 2013

and up (except Summit 174")

860201005 • Black

**\$59.99**







**DID YOU KNOW** The front and rear bumpers – and the cargo rack – are designed to hold the multi-mount winch, so you can easily pull from where you need to.



**MULTI-MOUNT 2500 WINCH**

- 2,500 lb (1,134 kg) capacity steel-cabled winch with Roller Fairlead.
- Standard 2" receiver-style mount.
- Includes: sidemount carry bracket, 6' (1.83 m) wired remote control, wiring harness and hardware.
- Fits on XU Front Bumper with 2" Receiver (860200987) and XU Rear 2" Receiver for Heavy-Duty Bumper (860201062).

860200992 • Black  
**\$869.99**

**SYNTHETIC WINCH CABLE**

- Easier to manipulate than steel cable.
- Replaces the original cable on any factory installed Warn® winch or sold as an accessory by BRP.
- Kit includes synthetic rope and rock guard sleeve.
- Always use with Hawse Guide (860201143) to prevent premature wear.
- 50' (15 m) long, 3,000 lb (1,361 kg) of strength.
- Fits on Multi-Mount Winch (860200992).
- Hawse Guide (860201143) must be installed.

715000539  
**\$114.99**



**WINCH ACCESSORIES KIT**

- Get the most out of your winch.
- Double your pulling power, change your pulling direction and keep your winch in proper working order.
- Includes tree straps, snatch block and shackle.
- To be used with Multi-Mount Winch (860200992).

715002409  
**\$104.99**



**HAWSE GUIDE**

- Replaces Roller Fairlead for longer cable life.
- For use with synthetic cable only.
- Replaces Roller Fairlead when synthetic cable (715000539) is installed.

860201143 • Black  
**\$49.99**



**NEW**



- PREFILTER GRILLE KIT**
- Prevents water and snow intrusion with a clean, integrated look.
  - Easily removable bottom grille.
  - Snap-in top grille.
  - Airbox pop-off valve filter.

REV (G4)  
860201224  
**\$104.99**

**NEW**



- HEAVY-DUTY AIR INTAKE FILTERS**
- Prefilter to prevent water intrusion and snow buildup.
  - Reinforce intake filters, preventing damage in heavy use.
  - Replacement for stock filters.

REV (G4)  
860201399  
**\$99.99**

**VENT KIT FOR SIDE PANELS**

- Fast air-evacuating overmolded prefilter vents.
- Easy do-it-yourself installation onto premarked production side panels.
- 1 3/4" holesaw required.
- Use in conjunction with your stock vehicle panels.
- For racing applications only.

**DID YOU KNOW** The inside of all REV-XM and REV-XS side panels is pre-marked for optimal placement of the vents.



REV-XM  
• Kit includes vents for both side panels (24x).  
• Foam with foil included.  
REV-XM  
860200609 • Black  
**\$179.99**



REV-XS  
• Kit includes vents for both side panels (13x).  
• Foam with foil included.  
REV-XS  
860200750 • Black  
**\$109.99**



**VENT KIT**

- Assortment of replacement or additional vents (7x) with hardware.
- Can be installed on most body panels with relatively flat surface and 2.5 to 3.2 mm thickness.

All models  
860200684  
**\$54.99**

**REPLACEMENT FRONT PREFILTER**

REV-XM, REV-XS  
517305029 • Black  
**\$79.99**

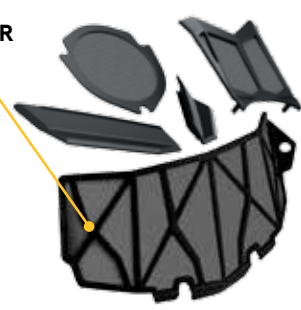

- PREFILTER GRILLE KIT**
- Fully integrated overmolded prefilter snap-in grilles.
  - Repel and prevent snow from entering bottom pan and hood openings.
  - Kit includes easily removable bottom pan grille, lower pan cover plugs, hood grille, and air-box pop-off valve prefilter.

REV-XM, REV-XS  
860200610 • Black  
**\$104.99**



- PREFILTER GRILLE KIT**
- Keeps snow and moisture out, lets air in.
  - Plastic frame molded over mesh for strength.
  - Installs easily.
  - Totally integrated design.
  - Kit includes filters for bottom pan and hood openings.
  - Note: Not compatible with Heavy-Duty Front Bumper with 2" Receiver (860200987).

REV-XU Expedition SE, LE, Skandic WT, SWT  
860201152 • Black  
**\$99.99**



- SHOCK PROTECTORS**
- Protect your shocks against tough weather conditions.
  - Color-matched nylon protectors.
  - Easy installation.
  - Sold in pairs.

280000327 • Bee  
**\$24.99**

860201128 • Black  
860201129 • White  
860201130 • Yellow  
**\$19.99**

# BRING YOUR STYLE TO THE SNOW WITH THE ONLY SLED WRAPS ENDORSED BY BRP



HiFi



Powdercolor



Antidote



Zinger



Overspray



Analog

SCS has led the industry with fresh looks that complement both sleds and riders. With designs from wild to mild, they can give your new – or older – sled a look all its own. Especially when you consider how they can customize an existing design with colors and logos, and even create a design you come up with.

The wraps are of the highest quality – 4 mil vinyl overlaid with an 8 mil UV protective laminate. You get bright vibrant colors that hold up to both the rigors of snowmobiling and harsh weather conditions.

Note: These new graphics are also offered on XM and XS platforms.



Available at participating Ski-Doo dealers and [www.scskidoowraps.com](http://www.scskidoowraps.com)

## LinQ 1+1 ERGO SEAT SYSTEM Fastest, easiest way to get a 2-up sled. Often copied, never duplicated.



**NEW**

### LinQ 1 + 1 ERGO SEAT SYSTEM

- New improved ergonomics.
- The ultimate in modular seating.
- Allows quick changes between 1-up and 2-up riding.
- Ergonomically correct positions for driver and passenger.
- Two easy tool-less steps:
  - 1- Clip in seat.
  - 2- Add LinQ 1 + 1 Backrest.

REV (G4) Summit, MXZ

860201268

**\$849.99**

**NEW**

### 1 + 1 SEAT

- Quick, easy installation and ideal ergonomics for driver and passenger.
- Full tunnel capacity is maintained and allows additional accessories to be added.

REV (G4)

860201267 • Black

**\$399.99**



**NEW**

### HEATED SEAT

- Add warmth with this heated seat.

REV-XS, REV-XM

860201458 • Black

**\$499.99**



**NEW**

### HEATED 1 + 1 GRIPS

- Allow your passenger to ride in comfort in all conditions.

REV (G4)

860201456

**\$159.99**



**NEW**

### LinQ 1 + 1 BACKREST ANCHOR BASE KIT

- Allows installation of LinQ 1 + 1 Backrest on more than one vehicle.

REV (G4)

860201321 • Black

**\$174.99**





**LinQ 1 + 1 COMPLETE SEAT SYSTEM**

- The ultimate in modular seating.
- Allows quick changes between 1-up and 2-up riding.
- Ergonomically correct positions for driver and passenger.
- Two easy tool-less steps:
  - 1- Clip in seat.
  - 2- Add LinQ 1 + 1 Backrest.

REV-XM, REV-XS, REV-XP & REV-XR (except GTX, Grand Touring), REV-XU Tundra

860200575

**\$824.99**



Watch the video of the LinQ 1 + 1 Complete Seat System in action. [www.ski-doo.com/genuine-parts-accessories-riding-gear/catalog-video](http://www.ski-doo.com/genuine-parts-accessories-riding-gear/catalog-video)



**1 + 1 SEAT**

- Quick, easy installation and ideal ergonomics for driver and passenger.
- Full tunnel capacity is maintained and allows additional accessories to be added.

REV-XM, REV-XS, REV-XP & REV-XR (except GTX, Grand Touring), REV-XU Tundra

860200665

**\$484.99**

Note: See p.164 for LinQ 1 + 1 Backrest Rubber Latch and Anchor Base Kit.



**LinQ 1 + 1 BACKREST**

- Option for 1 + 1 Seat (860200665) when not sold as a kit.
- Can be locked using a padlock (not included).

REV-XM, REV-XS, REV-XP & REV-XR (except GTX, Grand Touring), REV-XU Tundra

860200595

**\$434.99**



**1 + 1 PASSENGER MUFFS**

- Muffs fit snugly around the passenger handles and provide total warmth even on the coldest days.
- Easy to install and remove.

Fits seat with handles and air deflectors

860200831 • Black

**\$49.99**

Fits seat with handles only

860201028 • Black

**\$29.99**



**HEATED 1 + 1 GRIPS WITH GUARDS**

- Allow your passenger to ride in comfort in all conditions.
- Self disconnect.

2016-2017 models

860201322

Fits on 1 + 1 LinQ Backrest (860200595).

2015 models and prior

860200584

**\$159.99**



**2-UP SEAT**

- Extended seat providing convenient 2-up riding.
- Complete seat assembly with passenger strap.
- Replaces existing seat in seconds.
- Ideal use with LinQ Snowboard/Ski Rack (860201222).

REV-XP, REV-XR, REV-XU Tundra, REV-XM, REV-XS

860201314 • Black

**\$339.99**

**2 + 1 SEAT**

- 2 + 1 seat specifically designed for REV-XR GTX, Grand Touring platforms, allowing you to ride 3-up.
- Enables you to enjoy all the same benefits you have been accustomed to with previous models.

REV-XR GTX, Grand Touring

860200170<sup>‡</sup>

**\$349.99**

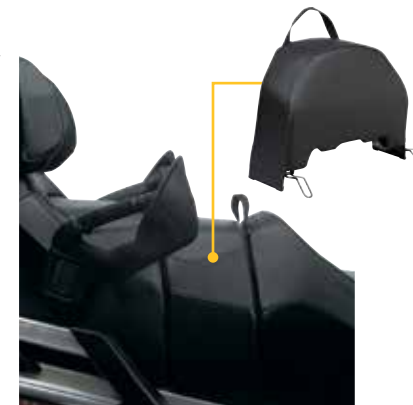

**ADJUSTABLE BACKREST**

- Adjustable, and works in conjunction with 2-up Seat (860201314).
- Positionable for passenger or driver use.
- Rigid steel frame and integrated foam pad.
- Easy, tool-less removal when not needed.

REV-XP, REV-XR, REV-XU Tundra, REV-XM, REV-XS

860200823 • Black

**\$289.99**



**SEAT BACKREST**

- Enhances the comfort level of your seat by adding this backrest option.

REV-XU Skandic

860200060

**\$329.99**



**2-UP SEAT / BACKREST COMBO**

- Extended seat with backrest providing convenient 2-up riding.
- Complete seat assembly with passenger strap.
- Replaces existing seat in seconds.
- Adjustable backrest enhances comfort level.
- Positionable for passenger or driver use.
- Easy, tool-less removal when not needed.

REV-XP, REV-XR, REV-XU Tundra, REV-XM, REV-XS

860200571

**\$629.99**



**PASSENGER SEAT / BACKREST FOR XU**

REV-XU WT, SWT, Expedition SE, LE, Xtreme

619400068

**\$729.99**



**ADJUSTABLE TOE-HOLD KIT**

- Kit provides easy adjustment to the toe-hold to match your riding style.

REV-XP, REV-XR, REV-XU Tundra, REV-XS, REV-XM (except 600 ACE & 900 ACE)

860200743 • Aluminum

**\$34.99**

860200744 • Black

**\$39.99**

**FRONT FOOTREST**

- A must for aggressive riders.
- Sloped plate provides a relaxed ankle position during long rides.

REV-XS, REV-XM

860200906 • Black

**\$84.99**

<sup>‡</sup>While supplies last.

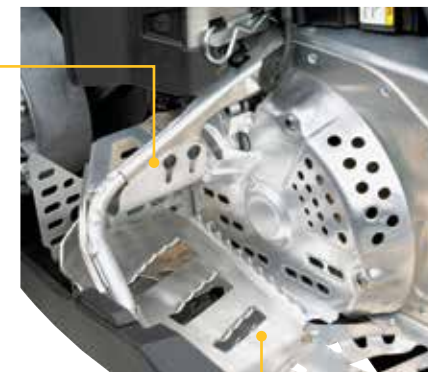

**REAR FOOTREST KIT**

- Provides additional boot grip at the rear of the tunnel when climbing.

REV-XM

860200889 • Black

**\$74.99**

**PASSENGER FOOTREST KIT**

- Fits 137" and up.
- Does not fit with rMotion adjusters.

REV-XP, REV-XR, REV-XU Tundra, REV-XS

860200810 • Aluminum

**\$44.99**



**LinQ. FAST. EASY. SECURE.  
AND NOW EVEN MORE VERSATILE.**



**NEW**

**SR 21 L LinQ TUNNEL BAG**

- Semi-rigid expandable LinQ tunnel bag.
- 21-liter (5.5 US gallons) capacity.
- Can be installed on top of Stackable LinQ Fuel Caddy - 15 L (860201265) or behind seat.
- All the benefits of LinQ - simple, fast, secure with an integrated lock.
- Utilizes LinQ mounting system (Patent US 8777531 & US 8875830).
- Easy one-second on/off tool-less system.
- LinQ Cargo Base Kit included (860200583).

REV (G4)

860201273

**\$179.99**



**DID YOU KNOW** Now you can take both extra fuel and a LinQ cargo bag on your short track sled – the NEW SR 21 L LinQ Tunnel Bag locks on top of the new Stackable LinQ Fuel Caddy - 15 L.



Short 10 + 3 L



Medium 19 + 3 L

**LinQ PREMIUM TUNNEL BAG**

- All the benefits of LinQ - simple, fast, secure with an integrated lock.
- Semi-rigid expandable tunnel bag.
- Easy one-second on/off tool-less system.

- Utilizes LinQ mounting system (Patent US 8777531 & US 8875830).
- LinQ Cargo Base Kit included (860200583).

REV (G4), REV-XM, REV-XS, REV-XP & REV-XR (except GTX, Grand Touring). Does not fit on REV-XU Tundra, 2008-2012. Drilling holes and LinQ Protective Decal (860200767) required. 2013 and up: Tunnel ready with decal and preperforated holes.

860200622 • Short 10 + 3 L

860200620 • Medium 19 + 3 L

**\$144.99**

**\$154.99**



**LinQ CARGO BOX - 40 L**

- Rigid molded plastic construction with integrated design.
- Provides dry, safe storage.
- Attaches using 2 sets of LinQ mounts (included).

Fits 137" and longer with 1-up seat or 1 + 1 seat

860201100 • Black

**\$359.99**

**LinQ SADDLEBAGS**

- Premium semi-rigid saddlebags, utilizing the LinQ mounting system (Patent US 8777531 & US 8875830).
- Easy attach and remove.
- Can be used in conjunction with additional LinQ mounted accessories at the same time.

- 26-liter capacity (2 x 13 L) (6.9 US gallons) (2 x 3.45 US gallons).
- LinQ Cargo Base Kit not included (860200583).
- LinQ Fastner included (715001707).

REV (G4), REV-XP, REV-XR, REV-XS, REV-XM (except Grand Touring, GTX & MXZ X-RS)

860200624 • Black

**\$249.99**



**DID YOU KNOW** The new Stackable LinQ Fuel Caddy - 15 L is redesigned to pour fuel easier.



**NEW**

**STACKABLE  
LinQ FUEL CADDY - 15 L**

- New design for easier pouring.
- 15-liter (4 US gallons) capacity.
- Allows a LinQ tunnel bag to stack on top for more storage.

Note: Fuel caddies cannot be stacked.

REV (G4)

860201265

**\$169.99**



**NEW**

**SHIMS FOR STACKABLE  
LinQ FUEL CADDY - 15 L**

- Use the new Stackable Fuel Caddy with this shim kit so you can add a LinQ Tunnel Bag on top.

REV-XS, REV-XM, REV-XP

860201432

**\$49.99**



**NEW**

**LinQ FUEL CADDY - 11 L**

- On/Off in a few seconds.
- 11-liter (3 US gallons) capacity.
- LinQ Cargo Base Kit included (860200583).
- Cannot be installed with the Luggage Rack Reinforcement Plates (860200798).

860200585

**\$129.99**

**LinQ FUEL CADDY  
REPLACEMENT  
CAP AND NOZZLE**

860201109

**\$10.99**

The low profile design of the LinQ Fuel Caddy keeps the sled's center of gravity low to maintain its excellent handling.



Get a closer look at the LinQ Premium Tunnel Bag and LinQ Fuel Caddy. Go to: [www.ski-doo.com/genuine-parts-accessories-riding-gear/catalog-video](http://www.ski-doo.com/genuine-parts-accessories-riding-gear/catalog-video)



This rack attaches and removes in seconds, so you mount it strictly when you need it. Also, you can use it with other LinQ accessories, like a bag or fuel caddy.



**LinQ SNOWBOARD/SKI RACK**

- The ultimate solution for carrying skis or snowboard equipment.
- Lightweight rack uses patented LinQ system for quick, easy mounting.
- Easy to convert from snowboard to skis in minutes - fits all sizes.
- Kit includes all necessary LinQ hardware.
- Requires appropriate heavy-duty rear bumper.

**REV-XP, REV-XM 154"**

**and longer**

860201222 • Black/Aluminum

**\$339.99**



**REV (G4)**

860201255 • Black/Aluminum

**\$399.99**



Watch how easy the LinQ Snowboard/Ski Rack is. Go to: [www.ski-doo.com/genuine-parts-accessories-riding-gear/catalog-video](http://www.ski-doo.com/genuine-parts-accessories-riding-gear/catalog-video)



**STRAP KIT FOR LinQ SNOWBOARD/SKI RACK**

- Replacement parts for Snowboard/Ski Rack (1 strap per kit).
- Can also be used for switching rack from snowboard to skis easily (2 kits required for conversion).
- Hardware included.

860201304 • Black

**\$20.99**

**INTERIOR PLASTIC SUPPORT FOR LinQ SNOWBOARD/SKI RACK**

511001061

**\$10.99**

**EXTERIOR PLASTIC SUPPORT FOR LinQ SNOWBOARD/SKI RACK**

511001059

**\$10.99**



**PROTECTIVE DECAL FOR LinQ SNOWBOARD/SKI RACK**

(Not illustrated)

- To protect your tunnel from ski tip scratches when using the LinQ Snowboard/Ski Rack.

516006982 • Clear

**\$6.99**



**SLIM TUNNEL BAG WITH LinQ SOFT STRAP**

- Utilizes LinQ Cargo Base Kit (860200583) and soft strap for mounting.
- Low profile, positioned flat on tunnel, for convenient out of the way storage.
- Easy access full wrap around zipper.
- Top mount shovel pocket.
- Utilizes LinQ mount with lightweight strap and buckle (included).
- LinQ Cargo Base Kit included (860200583).
- 15-liter (4 US gallons) capacity.

**137" and longer with 1-up seat**

860200935 • Black

**\$139.99**



**TUNNEL BACKPACK WITH LinQ SOFT STRAP**

- Utilizes LinQ Cargo Base Kit (860200583) and soft strap for mounting.
- Includes a compartment for the Ski-Doo Shovel (860200574) and 2.8 m Avalanche Probe (520000408) (not included).
- Quick-disconnect system instantly transforms the bag into a backpack.
- LinQ Cargo Base Kit (2x) (860200583) not included but required to mount the bag on the tunnel.
- 28-liter (7.4 US gallons) capacity.

**137" and longer with 1-up seat**

860200939 • Black

860200940 • Orange

**\$149.99**



**SHOVEL WITH SAW HANDLE**

- Lightweight shovel with retractable saw handle.
- Can be disassembled and easily stored on your sled.

860200574

**\$89.99**

**SAW & HANDLE REPLACEMENT FOR SHOVEL**

- Replacement saw blade and handle for Ski-Doo Shovel.

860200794

**\$44.99**

**2.8 M AVALANCHE PROBE**

- Lightweight, durable and strong 1/2" (12 mm) aluminum tubing construction.
- 7-16" (40 cm) color-coded sections.
- Weight: 13 oz. (370 g).

520000408

**\$104.99**



**RISER BLOCK BAG**

- Innovative 2-pocket carry bag for secure storage around the steering riser block.
- 3W heated insulated pocket design reduces the chance of water bottles freezing and increases the battery life of small electronic equipment.
- Includes RCA adaptor kit.
- Requires Heated Visor Kit (860201234) sold separately.

**Long**

REV-XP Summit, REV-XU Tundra,

REV-XM (for Risers 175 mm and up)

860200677 • 5-liter (1.32 US gallons)

**\$99.99**

**Short**

REV-XM, REV-XS, REV-XP, REV-XR,

REV-XU Tundra, except Grand Touring & GSX

860200676 • 3-liter (0.8 US gallon)

**\$89.99**





**NEW**

**LinQ ERGO SUMMIT SEAT BAG**

- LinQ seat bag for REV platform 4<sup>th</sup> generation Summit.
- Integrated storage that stays out of the way.
- 4-liter (1 US gallon) capacity.
- Easy on/off.
- Can be used with tunnel bags or fuel caddy.
- Vehicles with pull start require the Battery Cover and Support (860201407).

**REV (G4) Summit**

860201355 • Black

**\$109.99**

**OIL SUPPORT CADDY/ GOGGLE BAG**

- Multi purpose bag.
- Allows you to easily access and carry an extra liter of XPS oil or a spare set of goggles.
- Installs conveniently on top of the CVT cooling system.
- Models without E-TEC engine need the Acoustic Plate (512060847).

**REV-XM, REV-XS**

860200614 • Black

**\$49.99**



**EXTREME SUMMIT SEAT BAG**

- A must for extreme mountain riding.
- Low profile bag lets you add storage without getting in the way of your riding needs.
- Fully integrated and allows for the REV-XM seat to easily clip on/off in seconds without taking away any tunnel space.
- Works in conjunction with REV-XM seat.
- 5-liter (1.2 US gallons) capacity.
- Inner zipper to access underseat compartment.

**REV-XM**

860200745 • Black

**\$79.99**



**TUNNEL BAG**

- Includes a compartment for the Ski-Doo Shovel (860200574) (not included).
- Chassis premarked for easier installation of bags on tunnel.
- 40-liter (10.6 US gallons) capacity.
- Extension provides more cargo space when required.

**REV-XP, REV-XR, REV-XU Tundra, REV-XS, REV-XM**

860200824 • Black/White

**\$139.99**



**MXZ TUNNEL BAG**

- Utilizes our cleat and bag retaining system (Patent USD607,313).
- Innovative thermo-formed tunnel bag, designed for a slick look and rigid structure.
- Chassis premarked for easier installation of bags on tunnel.
- 25-liter (6.6 US gallons) capacity.

**REV-XP, REV-XR, XF, REV-XU Tundra, REV-XM, REV-XS**

860200826 • Soft

**\$99.99**



**NEW**

**CGX2 CAMERA**

- 4K HD and 1080p at 60fps.
- 2" LCD display screen.
- Waterproof housing of up to 50 m underwater and the 2.4gh waterproof remote.
- Comes with 32GB micro SD card class 10 and 9 mounts.
- Wi-Fi available to control your camera from your smart phone or tablet with the free i-Cyclaps App for iOS and Android.
- \*Exclusive to Ski-Doo dealers.

2866860090

**\$299.99**



**MONTANA<sup>+</sup> GPS AND SUPPORT KIT**

- One of the best GPS systems available, designed to fit your sled perfectly with plug-and-play hook-up.
- Glovebox Extension required (860200707) for REV-XS, REV-XM.
- Universal GPS Mount (860201018) required for REV-XU, REV-XR.

**REV-XM, REV-XS, REV-XU, REV-XR**

860201417

**\$659.99**



**✓ DID YOU KNOW** The Montana GPS has a screen lock feature so you can see where you're headed even during the roughest rides.

**NEW**

**GARMIN ZUMO<sup>+</sup> 590 GPS**

- The latest from GPS expert Garmin.
- 5" sunlight-readable, glove-friendly screen.
- Bluetooth<sup>®</sup> technology can pair with cell phones.
- US topo maps included, trail maps can be downloaded.
- Mounting cradle and harness included.
- Glovebox Extension / GPS Support (860201249) required for mounting.

**REV (G4)**

860201263

**\$899.99**



**NEW**

**GARMIN ZUMO 590 GPS MOUNT SUPPORT KIT**

- Mount for Garmin Zumo 590 GPS allows use on more than one vehicle.
- Plug-and-play wire harness.
- Included in Garmin Zumo 590 GPS (860201263)

**REV (G4)**

860201262

**\$184.99**



**GLOVEBOX LINER**

- Padded liner provides an inner bag within your glovebox storage.
- Provides a finished interior and additional protection to your items.
- Includes an organizer pocket for small items.
- Can be used with 3W Heater for Bags (515176786) (not included).

**REV-XM, REV-XS 2013 and prior**

860200678 • Black<sup>†</sup>

**\$54.99**

<sup>†</sup>While supplies last.



**GLOVEBOX LINER**

- Padded inner liner protects items.
- Design seals against snow intrusion.
- Glovebox Extension compatible.
- Can be used with 3W Heater for Bags (515176786) (not included).

**REV- XM, REV-XS 2014 and up**

860201084 • Black

**\$49.99**

**NEW**

**GLOVEBOX LINER**

- Thermoformed liner has a soft finish interior.
- Features one pocket to separate items.

**REV (G4)**

860201270

**\$49.99**





**CARGO BAG**

- Rugged all-purpose utility design.
- Sealed PVC construction.
- Large capacity (approx. 80 liters, 21 US gallons).
- Integrated attachment system.
- Includes rain cover for added resistance to the elements.
- Can also double as travel/duffle bag.

REV-XU Tundra 137", 154" & Summit

860200801

**\$164.99**



Rain Cover



**LinQ RETROFIT KIT FOR CARGO BAG**

(Not illustrated)

- 4 straps to adapt the Cargo Bag to LinQ system.
- LinQ Cargo Base Kit (2x) (860200583) not included but required to mount the bag on the tunnel.

860200941 • Black

**\$19.99**



**NEW**

**GLOVEBOX EXTENSION / GPS SUPPORT**

- New design for REV platform 4<sup>th</sup> generation models doubles the storage with 4-liter (1 US gallon) capacity.
- Can be used with or without windshield.
- Door provides perfect mount for GPS (sold separately).
- Replaces stock storage compartment cover.

REV (G4)

860201249 • Black

**\$99.99**



**GLOVEBOX EXTENSION**

- Increases storage capacity by 50%.
- Replaces stock storage compartment cover.
- Face door allows for perfect positioning and mounting of GPS.
- GPS sold separately.
- 2-liter (0.5 US gallon) capacity.

REV-XM, REV-XS

860200707 • Black

**\$79.99**



**DASHBOARD BAG**

- Easy-access bag designed to provide extra storage.
- 2-liter (0.5 US gallon) capacity.

REV-XP

860201176 • Black

REV-XR, REV-XU Tundra

860201177 • Black

**\$49.99**



**TUNNEL ROLL TOP BAG - MEDIUM 25 L WITH LinQ SOFT STRAP**

- Utilizes LinQ Cargo Base Kit (860200583) and soft strap for mounting (included).
- Compact roll-up polyester bag.
- Expandable to 25-liter (6.6 US gallons) capacity.
- Convenient, lightweight storage.

REV (G4) REV-XP, REV-XR, REV-XS, REV-XM (except Grand Touring and GTX)

860200787 • Black

**\$89.99**

**COMBO BAG**

- Utilizes easy on/off clip system.
- No need to remove seat.
- Multiple pockets.
- 45-liter (11.9 US gallons) capacity.

REV-XP, REV-XR, REV-XS, REV-XU

860200623

**\$129.99**



**TANK BAG**

- Easy-access bag with full-length zipper.
- Access fuel cap without removing bag.
- 11-liter (2.9 US gallons) capacity.

REV-XP

860200297 • Black<sup>‡</sup>

**\$94.99**

<sup>‡</sup>While supplies last.



**TANK BAG 5 L**

- Low profile bag.
- Easy-to-view map pocket.
- Access fuel cap without removal.
- Ready for 3W Heater for Bags (515176786) (not included).

REV-XM, REV-XS

860200974 • Black

**\$94.99**



**HEATED TANK BAG**

- Easy-access bag with full-length zipper.
- Map pocket.
- Access gas cap without removing bag.
- 3W heated, insulated pocket for battery-powered electronics, e.g. cell, GPS.
- Access to the 12V plug-in port.
- 2.4-liter (0.6 US gallon) capacity.

• Includes RCA adaptor plug kit.  
• Requires Heated Visor Kit (860201234) (not included but required for installation).

REV-XR, REV-XU Tundra

860201127 • Black

**\$94.99**



**LinQ 1 + 1 BACKREST BAG**

- Attaches itself on the LinQ 1 + 1 Backrest (860200595) and easily on/off.
- Expandable 14-liter + 3-liter (3.7 US gallons + 0.8 US gallon) capacity.
- Can be used in conjunction with the Fuel Caddy or Medium/Short Premium Tunnel Bag.

1 + 1 & Grand Touring Backrest

860200621 • Black

**\$164.99**



**SEMI-RIGID TUNNEL BAG**

- Versatile multi-configuration bag.
- High-quality hard topped for better protection.
- Use alone or with Modular Tunnel Bag Extension (860200173).
- Attaches to backrest when combined with Fuel Caddy.
- 31.3-liter (7.1 US gallons) capacity.

REV-XR GTX & Grand Touring, REV-XS Grand Touring

860200174 • Black

**\$154.99**



**MODULAR TUNNEL BAG EXTENSION**

- Versatile multi-configuration bag.
- Use alone, with or without Fuel Caddy, or with Semi-Rigid Tunnel Bag (860200174).
- Installs and removes easily, horizontally or vertically.
- 38-liter (10 US gallons) capacity.

REV-XR GTX & Grand Touring, REV-XS Grand Touring

860200173 • Black

**\$144.99**



**BRING IT ALL,  
OR ONLY WHAT YOU NEED**

1. Gun Boot 6.0 Impact by KOLPIN
2. Gun Boot Rack
3. XU Rear Heavy-Duty Bumper / p. 122

**EXTRA LARGE  
XU BAG**

- Extra large 150-liter (40 US gallons) capacity shaped to fit utility model racks.
- Weather-resistant polyester, includes compartment organizer.

REV-XU Skandic WT, SWT,  
REV-XU Expedition SE,  
LE, Xtreme

860201179 • Black

**\$309.99**



**UNDER SEAT  
STORAGE BAG**

- Padded bag protects your items.
- Makes them easy to transport.

REV-XU Skandic WT, SWT,  
REV-XU Expedition SE, LE & Xtreme

860201063 • Black

**\$69.99**



**CARGO BOX**

- 45-liter (11.88 US gallons) capacity.
- Made of durable polyethylene.
- Provides additional secure storage.
- Convenient flip top provides easy access to stored goods.
- Standard on SE models.

REV-XU Skandic WT, SWT,  
REV-XU Expedition SE, LE & Xtreme

860200395 • Black

**\$249.99**



**RACK AND NET KIT  
FOR CARGO BOX**

- Rack to carry additional items on top of Cargo Box (860200395).
- Net to better secure items inside Cargo Box cover.

860201025 • Black

**\$129.99**

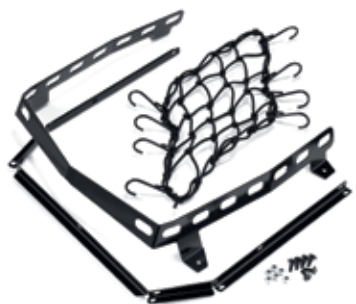

**CARGO CENTER BOX**

- 20-liter (5.28 US gallons) capacity.
- Easily interchangeable with passenger seat.
- Provides additional storage space.
- Can be padlocked.
- Can be installed in conjunction with Cargo Box (860200395).

REV-XU Skandic WT, SWT,  
REV-XU Expedition SE, LE, Xtreme

860200732 • Black

**\$269.99**



**GUN BOOT 6.0 IMPACT<sup>+</sup> BY KOLPIN<sup>+</sup>**

- Features largest interior room of all Kolpin Gun Boot cases.
- Extra room for pistol-grip-type weapons and small bipods.
- Easily fits firearms up to 51" (130 cm) in total length.
- Provides ample room for 60 mm scopes.
- Hatchback design allows easy access.
- Snap-close cover with locking capability.
- Ergonomically designed handle and molded attachment points for sling.

715001419

**\$79.99**



**GUN BOOT RACK**

- Required for Gun Boot use on vehicle.
- Can be installed on either side of the sled, facing forward or rearward and at any angle.

REV-XU Skandic WT & SWT, REV-XU Expedition SE, LE, Xtreme

860200984 • Black

**\$164.99**



There's extra room for pistol-grip-type weapons and small bipods, left and right hand bolt-action rifles and shotguns.



**LinQ REAR CARGO RACK**

- Provides mounting point for LinQ Cargo Base Kit (860200583).
- Compatible with LinQ fuel caddy and tunnel bags.
- Easily interchangeable with passenger seat.
- Provides additional cargo space.

REV-XU Skandic WT, SWT, Expedition SE, LE, Xtreme

860200914 • Black

**\$189.99**



**REAR RACK EXTENSION**

- Delivers increased cargo space.
- Does not fit with XU Rear Heavy-Duty Bumper (860201106).

REV-XU Skandic WT, SWT, REV-XU Expedition SE, LE, Xtreme

860200700 • Black

**\$79.99**



**LUGGAGE RACK REINFORCEMENT PLATES**

- Additional reinforcement for your long and short rear rack.
- Made of high strength steel.
- Sold in pairs.

REV-XM, REV-XP, REV-XR, REV-XU Tundra, REV-XS

860200798 • Black

**\$44.99**





**286 PHANTOM SERIES STUDS & SUPPORT PLATES BY WOODY'S**

- A complete line of traction products developed specifically for Ski-Doo's REV-XP, REV-XR, REV-XS & REV (G4) tracks.
- Due to the unique track design, this is the only traction product available to maintain track warranty and track life.
- Kit complete with stud, nut and support plate.
- The only traction product approved by BRP.

**REV-XS, REV-XP, REV-XR, REV (G4)**

860200718 • 5/16 - 1.075" Pack of 84 (for 120" track)	860200720 • 5/16 - 1.075" Pack of 500	860200722 • 5/16 - 1.325" Pack of 96 (for 137" track)
<b>\$259.99</b>	<b>\$1,414.99</b>	<b>\$334.99</b>
860200719 • 5/16 - 1.075" Pack of 96 (for 129" & 137" track)	860200721 • 5/16 - 1.325" Pack of 84 (for 120" track)	860200723 • 5/16 - 1.325" Pack of 500
<b>\$304.99</b>	<b>\$284.99</b>	<b>\$1,553.99</b>



860201281 • 5/16 - 1.325"  
Pack of 90 (for 129" track)  
**\$299.99**

**PHANTOM SHARP STUDS & SUPPORT PLATES BY WOODY'S**

- All the benefits of 286 Phantom Series studs.
- Unique track design makes it the only traction product available to maintain track warranty and track life.
- Kit complete with stud, nut and support plate.
- The only traction product approved by BRP.

**REV-XS, REV-XP, REV-XR, REV (G4)**

860200729 • 5/16 - 1.325" Pack of 84 (for 120" track)	860200731 • 5/16 - 1.325" Pack of 500
<b>\$334.99</b>	<b>\$1,934.99</b>
860200730 • 5/16 - 1.325" Pack of 96 (for 129" & 137" track)	
<b>\$374.99</b>	

**TUNNEL PROTECTOR KIT**

- New design, installs in seconds.
- Provides proper protection for stud installation or pre-studded track.
- So unique it's patent pending.



**REV (G4)**  
860201280  
• Protects your bulkhead and heat exchangers in all conditions.

**REV-XP (except fan-cooled), REV-XR, REV-XS 120", 129" & 137"**  
860200802  
**\$99.99**

**REV-XU Expedition (2011 & up), REV-XU Skandic SWT, WT**  
860200757  
**\$99.99**

**REV-XP fan-cooled 120" & 137", REV-XU Tundra 137"**  
860200381  
**\$54.99**



To install the studs, always use the installation tools, procedures and torque specified in the instructions. Proper installation provides maximum product longevity and helps prevent track damage. BRP recommends that studs be installed by authorized BRP dealers, and on approved pre-patterned tracks only. These tracks come standard on most 2017 Ski-Doo snowmobiles. Look for this symbol on your track. Woody's products are designed to fit and interact with each other. The stud nut and support plate form a complete unit. The use of aggressive skis, ski carbide runners or studs will alter the handling of your snowmobile, particularly in terms of manoeuvrability, acceleration and braking. Please refer to your Operators Guide for more details.

**TRACTION MADE EASIER.**

At BRP we make our snowmobiles to be easy, including adding traction for riding in icy conditions. So we've gone to great lengths to engineer and test parts that install easier and integrate with your sled – things like tracks pre-marked for stud installation, carbide runners of different sizes and new snap-in tunnel protectors for the 4<sup>th</sup> Generation REV sleds. So if you've made the decision to add more traction, be confident we have you covered with the right parts. Here is some advice on choosing and installing them.

**Balance your traction**

Be sure to consider both front and rear traction to balance your sled's handling. Too much front bite allows the rear or track to be loose and too much rear traction pushes the front through corners.

**Start with the front carbides**

Choose how much bite you want up front first. If you want really positive turning, Executive Carbides with 8" (20 cm) of 60° turning carbide are a good choice. Options for more or less turning carbide are available, too. Pilot TS adjustable skis have four types available with both different amount of carbide and depth. Some experimenting with different types might be useful for you to find just the right combination for your riding style and predominant conditions.

**Stud Your Track**

Using studs in your track provides you with better control and confidence in slippery spots and balances ski-runner carbides. Your Ski-Doo snowmobile's track is pre-marked with the right number and location for studs that would balance nicely with the Executive Carbides for most riders 84 studs for a 120" (305 cm) track; 90 studs for a 129" (327 cm) track; 96 studs for a 137" (348 cm) track.

**Does it matter which studs you use on your Ski-Doo snowmobile?**

Yes. Most new Ski-Doo trail sleds built on the REV-XS and REV (G4) platforms use the RipSaw Lite track, which is a single-ply design to make it lighter and more responsive. This unique construction means the studs and backer plates need to be specially

designed to grip the track effectively. The Woody's 286 Phantom stud and backer kits available through BRP are the only studs that have been tested by BRP and proven to provide the performance and durability required for use with this track design.

**Just install the studs, is that all there is to it?**

You need to make sure that the proper tunnel protectors are installed on your snowmobile, also. On most Ski-Doo sleds it's a very simple operation to slide the original short protectors out, and slide the new taller protectors back into the channels of your heat exchangers. The new REV (G4) is even easier with a patent-pending snap-in protector design that takes just minutes to install. Be sure to consult your dealer for the proper protector height for your track and stud height to prevent damage.

**Is my track still warrantied if studs are installed?**

Because the 286 Phantom studs and backer plates grip the track in a unique way and hold the assembly solidly, your warranty is maintained if the studs are installed properly on the pre-marked locations. These are the only traction products that maintain the warranty.

We recommend you have your authorized BRP dealer install your studs and on pre-patterned tracks only. If you do choose to do it yourself, be sure to always use the proper installation tools, procedures and torque specified in the instructions. Proper installation provides maximum product longevity and helps prevent track damage.

**YOUR CONNECTION TO THE SNOW.**



ICE COBRA 1.6



ICE RIPPER XT



POWDER MAX 3

**POWDER MAX / FLEXEDGE**

- The track edges bend, making roll-up easy and predictable.
- Exclusive FlexEdge technology available in Powder Max, Powder Max 2 & 3 and Cobra 1.6 profiles.
- From 137" to 174".

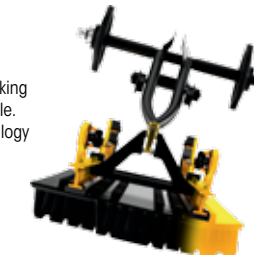

PITCH	WIDTH	LENGTH	LUG HEIGHT	PROFILE	CLIP	SKU	PRICE	
3.50"	16"	154"	2.50"	PowderMax Light	1 clip every 2 profiles	504153473	<b>\$979.99</b>	NEW
	16"	154"	3.00"	PowderMax Light	1 clip every 2 profiles	504153324	<b>\$1,359.99</b>	NEW
	16"	165"	2.50"	PowderMax Light	1 clip every 2 profiles	504153474	<b>\$1,019.99</b>	NEW
	16"	165"	3.00"	PowderMax Light	1 clip every 2 profiles	504153368	<b>\$1,359.99</b>	NEW
3.00"	16"	154"	3.00"	Powder Max 3 / FlexEdge	1 clip every 2 profiles	504153349	<b>\$1,359.99</b>	
	16"	163"	3.00"	Powder Max 3 / FlexEdge	1 clip every 2 profiles	504153224	<b>\$1,359.99</b>	
	16"	174"	3.00"	Powder Max 3 / FlexEdge	1 clip every 2 profiles	504153234	<b>\$1,599.99</b>	
	15"	120"	1.25"	ICE Ripper XT	Full clip	504153100	<b>\$849.99</b>	
2.86"	15"	120"	1.00"	RipSaw	Full clip	504152760	<b>\$549.99</b>	
	15"	120"	1.25"	RipSaw	Full clip	504152606	<b>\$599.99</b>	
	15"	120"	1.50"	RipSaw	Full clip	504153205	<b>\$689.99</b>	
	15"	129"	1.25"	ICE Ripper XT	Full clip	504153345	<b>\$869.99</b>	
	15"	129"	1.25"	RipSaw	Full clip	504153344	<b>\$669.99</b>	
	15"	129"	1.25"	RipSaw 2 PLY	Full clip	504153346	<b>\$669.99</b>	
	15"	129"	1.50"	RipSaw 2 PLY	Full clip	504153347	<b>\$789.99</b>	
	15"	137"	1.25"	Cobra	1 clip every 2 profiles	504152838	<b>\$719.99</b>	
	15"	137"	1.60"	ICE Cobra 1.6	Full clip	504153399	<b>\$859.99</b>	
	15"	137"	1.25"	ICE Ripper XT	Full clip	504153101	<b>\$859.99</b>	
	15"	137"	1.25"	RipSaw	Full clip	504152905	<b>\$699.99</b>	
	15"	137"	1.25"	RipSaw (SilentDrive System)	Full clip	504153480	<b>\$699.99</b>	NEW
	15"	137"	1.25"	ICE Ripper XT (SilentDrive System)	Full clip	415130062	<b>\$859.99</b>	
	15"	137"	1.50"	RipSaw	Full clip	504153237	<b>\$819.99</b>	
	16"	137"	1.25"	Cobra	1 clip every 2 profiles	504152907	<b>\$749.99</b>	
	16"	137"	1.75"	Powder Max	1 clip every 2 profiles	504152803	<b>\$779.99</b>	
	16"	137"	1.75"	Powder Max / FlexEdge	Full clip	504153294	<b>\$779.99</b>	
	16"	137"	2.25"	Powder Max	Full clip	504153103	<b>\$909.99</b>	
	16"	137"	2.25"	Powder Max / FlexEdge	Full clip	504153293	<b>\$909.99</b>	
	16"	137"	1.25"	RipSaw	1 clip every 2 profiles	504152734	<b>\$699.99</b>	
	16"	137"	1.50"	WT Lite	1 clip every 2 profiles	504153102	<b>\$819.99</b>	
	16"	146"	1.60"	Cobra 1.6 / FlexEdge	Full clip	504153400	<b>\$899.99</b>	
	16"	146"	2.00"	Powder Max / FlexEdge	1 clip every 2 profiles	504153348	<b>\$879.99</b>	
	16"	146"	2.25"	Powder Max	1 clip every 2 profiles	504153014	<b>\$829.99</b>	
16"	146"	2.25"	Powder Max / FlexEdge	1 clip every 2 profiles	504153222	<b>\$829.99</b>		
16"	146"	2.50"	Powder Max 2	1 clip every 2 profiles	504153008	<b>\$929.99</b>		
16"	146"	2.50"	PowderMax 2 / FlexEdge	1 clip every 2 profiles	504153198	<b>\$929.99</b>		
16"	154"	1.50"	Charger	1 clip every 2 profiles	504152761	<b>\$889.99</b>		
16"	154"	2.25"	Powder Max	1 clip every 2 profiles	504153015	<b>\$919.99</b>		
16"	154"	2.25"	Powder Max / FlexEdge	1 clip every 2 profiles	504153223	<b>\$919.99</b>		
16"	154"	2.50"	Powder Max 2	1 clip every 2 profiles	504153009	<b>\$979.99</b>		
16"	154"	2.50"	PowderMax 2 / FlexEdge	1 clip every 2 profiles	504153199	<b>\$979.99</b>		
16"	154"	2.50"	ProLite		504153396	<b>\$1,039.99</b>		
20"	154"	1.25"	Utility	1 clip every 3 profiles	504152817	<b>\$919.99</b>		
20"	154"	1.50"	Extreme Utility	1 clip every 3 profiles	605613004	<b>\$919.99</b>		
20"	154"	1.25"	ICE Ripper	Full clip	504153036	<b>\$1,149.99</b>		
20"	154"	1.50"	ICE Ripper	Full clip	504153037	<b>\$1,299.99</b>		
16"	163"	2.25"	Powder Max	1 clip every 2 profiles	504153016	<b>\$969.99</b>		
16"	163"	2.50"	Powder Max 2	1 clip every 2 profiles	504153010	<b>\$1,019.99</b>		
16"	163"	2.50"	PowderMax 2 / FlexEdge	1 clip every 2 profiles	504153200	<b>\$1,019.99</b>		
15"	121"	1.25"	ICE Ripper	Full clip	504152654	<b>\$799.99</b>		
15"	121"	1.25"	RipSaw	Full clip	504152558	<b>\$649.99</b>		
2.52"	16"	136"	1.25"	Track	1 clip every 3 profiles	504152456	<b>\$699.99</b>	
	24"	156"	1.25"	ICE Ripper for SWT	Full clip	504153171	<b>\$919.99</b>	



COBRA WT



ICE ATTAK XT



RIPSAW II 1.5



BACKCOUNTRY X



PITCH	WIDTH	LENGTH	LUG HEIGHT	PROFILE	CLIP	SKU	PRICE
2.52"	15"	121"	1.063"	ICE Attak	Full clip	9028H	\$729.99
	15"	121"	1.35"	Cobra	Full clip	9052H	\$639.99
	15"	136"	1.35"	Cobra	Full clip	9061H	\$699.99
	15"	121"	1.22"	ICE Attak XT	Full clip	9200H	\$789.99
	15"	121"	1.25"	RipSaw II	Full clip	9214H	\$619.99
	15"	121"	1.25"	RipSaw	Full clip	9968H	\$649.99
	15"	121"	1.25"	RipSaw	Full clip	9968H144	\$669.99
	15"	136"	1.25"	RipSaw	Full clip	9969H	\$699.99
	15"	121"	1.5"	Intense	Full clip	9930C	\$669.99
	15"	121"	1"	Energy	1 clip every 3 profiles	9793T	\$489.99
2.86"	24"	156"	1.75"	Cobra SWT	Full clip	9260U	\$1,169.99
	16"	137"	2.31"	Challenger	Full clip	9204M	\$909.99
	15"	137"	1.35"	Cobra	Full clip	9093H	\$719.99
	16"	137"	1.38"	ICE Attak	Full clip	9134H	\$889.99
	15"	120"	1.25"	ICE Ripper XT	Full clip	9164H	\$849.99
	15"	120"	1.22"	ICE Attak XT	Full clip	9190H	\$799.99
	15"	137"	1.22"	ICE Attak XT	Full clip	9191H	\$859.99
	15"	120"	1.25"	RipSaw II	Full clip	9209H	\$649.99
	15"	137"	1.25"	RipSaw II	Full clip	9223H	\$699.99
	15"	129"	1.22"	ICE Attak XT	Full clip	9236H	\$869.99
	15"	120"	1.35"	Cobra	Full clip	9284H	\$649.99
	15"	120"	1.6"	ICE Cobra 1.6	Full clip	9244C	\$779.99
	16"	137"	1.6"	ICE Cobra 1.6	Full clip	9249C	\$869.99
	15"	120"	1.75"	Back Country X	Full clip	9287C	\$699.99
	15"	137"	1.75"	Back Country X	Full clip	9289C	\$779.99
	15"	120"	1.6"	Cobra 1.6	Full clip	9291C	\$739.99
	15"	129"	1.6"	Cobra 1.6	Full clip	9292C	\$789.99
	15"	120"	1.5"	RipSaw II 1.5	Full clip	9304C	\$749.99
15"	129"	1.5"	RipSaw II 1.5	Full clip	9305C	\$789.99	
15"	137"	1.5"	RipSaw II 1.5	Full clip	9306C	\$819.99	
20"	154"	1.5"	Cobra WT	Full clip	9196U	\$919.99	
3.00"	16"	162"	3"	Challenger X3	Full clip	C9219M	\$1,359.99



**SLIDER SHOES**

- Custom color-matched slider shoes with built-in wear marker.
- Long-lasting, impact-resistant.
- For all slide rail lengths.
- Easy-cut to desired length.

**146" SC-5 Mountain & tMotion**

- 503191499 • Black
- 503191695 • Yellow
- 503191947 • White

**154" SC-5 Mountain & tMotion**

- 503191198 • Black
- 503191696 • Yellow
- 503191948 • White

**163" SC-5 Mountain & tMotion**

- 503191501 • Black
- 503191697 • Yellow
- 503191949 • White

**\$24.99**

**137" rMotion Grand Touring 900 ACE**

- 503193449 • Black

**120" SC-5 & rMotion**

- 503191301 • Black
- 503191693 • Yellow
- 503191945 • White
- 503192562 • Red

**137" SC-5 & rMotion**

- 503191306 • Black
- 503191694 • Yellow
- 503191946 • White
- 503192563 • Black

**\$19.99**

**174" tMotion**

- 503193819 • Black
- 503194506 • Sunburst Yellow
- 503194505 • White

**\$29.99**

**NEW**

**REV (G4) 154"**

- 503194251 • Black

**NEW**

**REV (G4) 165"**

- 503194254 • Black
- 503194520 • Orange

**\$24.99**



**LIGHTWEIGHT WHEEL**

- Color-matched lightweight snowmobile wheels.

**REV (G4), REV-XM, REV-XS, REV-XP, REV-XR**

**141 mm**

- 503191621 • Yellow
- 503191622 • Full Moon
- 503191942 • White
- 503192794 • Black

**141 mm - rMotion**

- 503193477 • Black

**\$39.99**

**147 mm - rMotion**

- 503193376 • Black

**152 mm**

- 503191755 • Black

**180 mm**

- 503191626 • Yellow
- 503191627 • Full Moon
- 503191742 • Black
- 503191943 • White

**180 mm - rMotion**

- 503192766 • Black

**200 mm**

- 503191450 • Yellow
- 503191625 • Full Moon
- 503191741 • Black
- 503191944 • White

**200 mm - T3**

- 503194055 • Black

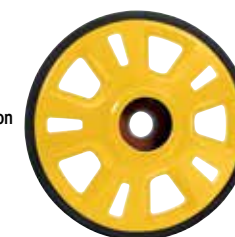

**EXTRA IDLER WHEEL KIT**

- Reduces drag and rolling resistance.
- Includes 2 wheels, brackets and hardware.

**REV (G4), REV-XM, REV-XM Summit X with T3 package**

**860201183 • 152 mm**

**REV-XP, REV-XR, except rMotion**

**860201230 • 141 mm**

**\$69.99**



**4<sup>th</sup> REAR WHEEL KIT**

- 4<sup>th</sup> rear idler design reduces drag and rolling resistance.
- Works in conjunction with stock 3 wheel setup.

**REV-XS, REV-XP, REV-XR 120" & 137"**

**860200358 • 180 mm**

**\$49.99**



**DS-3 SKI TIP KIT**

- Easy-install custom color tips changes the appearance of your sled in minutes.
- Adds flotation on the front of the DS-3 ski.
- Sold in pairs with mounting hardware.

Fits vehicles with DS-3 skis  
860201214 • Black



860201501 • Sunburst Yellow  
**\$69.99**



**PILOT 5.7 SL SKIS**  
TOURING

**PILOT 5.7 SKIS**  
TRAIL SPORT / PERFORMANCE

**PILOT 5.7R SKIS**  
PERFORMANCE



**PILOT DS SKIS**  
MOUNTAIN PERFORMANCE

**PILOT DS-2**  
MOUNTAIN PERFORMANCE

**PILOT DS-3**  
MOUNTAIN PERFORMANCE

# SKIS

**PLATFORMS**

REV (G4) • REV-XP • REV-XR • REV-XU • REV-XS • REV-XM • REV

RIDING STYLE	TOURING	TRAIL SPORT / PERFORMANCE		PERFORMANCE	MOUNTAIN PERFORMANCE		
PILOT	PILOT 5.7 SL 2 carbides/ski	PILOT 5.7 1 or 2 carbides/ski**	PILOT TS ADJUSTABLE 1 carbide/ski	PILOT 5.7R 1 carbide/ski	PILOT DS 1 carbide/ski	PILOT DS-2 1 carbide/ski	PILOT DS-3 1 carbide/ski
DESCRIPTION	<ul style="list-style-type: none"> <li>• Reduces steering effort and darting.</li> <li>• Specifically designed for Touring applications.</li> <li>• Skis sold individually.</li> </ul>	<ul style="list-style-type: none"> <li>• Lightweight single runner skis provide virtually effortless steering at low speeds, and constant grip without compromise at higher speeds.</li> </ul>	<ul style="list-style-type: none"> <li>• The industry's first and only adjustable ski: the Pilot TS Skis are the critical factor in steering precision and effort, yet their performance is dependent on snow conditions, which can change in hours.</li> <li>• With the Pilot TS ski, you can dial-in ski bite for conditions or your riding style by turning a knob on the ski leg.</li> <li>• It raises or lowers the ski runner over a range of 1/2" (12.5 mm).</li> <li>• This thin runner and new square keel design work together to make darting a thing of the past.</li> <li>• Easy-install custom color ski changes the appearance of your sled in minutes.</li> <li>• Patent pending US20150314799A1</li> </ul>	<ul style="list-style-type: none"> <li>• Same single keel ski equipped on the RS race sled.</li> <li>• Designed for aggressive riders.</li> </ul>	<ul style="list-style-type: none"> <li>• Designed specifically for mountain riding.</li> <li>• Vertical outer edge dramatically improves sidehilling bite.</li> <li>• Narrower and thinner, yet stiffer for dependable steering and carving.</li> <li>• Boot grips more effective than ever.</li> <li>• Carbides sold separately.</li> <li>• Skis sold individually.</li> </ul>	<ul style="list-style-type: none"> <li>• Keel design offers unmatched steering performance when used in conjunction with new ski leg.</li> <li>• Lower steering effort, increased agility and predictability.</li> <li>• Color options available to customize your sled.</li> <li>• Sold individually.</li> </ul>	<ul style="list-style-type: none"> <li>• Designed to work with deeper and longer tracks.</li> <li>• 12 mm deeper keel than DS-2.</li> <li>• Redesigned top-side bracing reduces weight of each ski by 0.28 lb (125 g).</li> <li>• Sold individually.</li> </ul>

**COLORS**

<b>Black</b>	Left	505072548	505072854	505073786	505072205	505073100	505073227	505073568
	Right	505072548	505072855	505073796	505072205	505073100	505073227	505073568
<b>Yellow</b>	Left	N/A	505073028	N/A	N/A	N/A	505073278	N/A
	Right	N/A	505073029	N/A	N/A	N/A	505073278	N/A
<b>Sunburst Yellow</b>	Left	N/A	505073575	505073851	N/A	N/A	505073658	505073627
	Right	N/A	505073576	505073852	N/A	N/A	505073658	505073627
<b>Black/Yellow</b>	Left	N/A	505073021	N/A	N/A	N/A	N/A	N/A
	Right	N/A	505073022	N/A	N/A	N/A	N/A	N/A
<b>Black/White</b>	Left	N/A	505073023	N/A	N/A	N/A	505073279	N/A
	Right	N/A	505073024	N/A	N/A	N/A	505073279	N/A
<b>Viper Red</b>	Left	N/A	505073005	N/A	N/A	N/A	N/A	N/A
	Right	N/A	505073006	N/A	N/A	N/A	N/A	N/A
<b>Lava Red</b>	Left	N/A	N/A	N/A	N/A	N/A	505073510	N/A
	Right	N/A	N/A	N/A	N/A	N/A	505073510	N/A
<b>Orange Crush</b>	Left	N/A	505074071	505074067	N/A	N/A	505073511	505074023
	Right	N/A	505074072	505074068	N/A	N/A	505073511	505074023
<b>Race Orange</b>	Left	N/A	505073645	N/A	N/A	N/A	505073654	N/A
	Right	N/A	505073646	N/A	N/A	N/A	505073654	N/A
<b>Manta Green</b>	Left	N/A	N/A	N/A	N/A	N/A	505073354	505073990
	Right	N/A	N/A	N/A	N/A	N/A	505073354	505073990
<b>PRICE</b>		<b>\$119.99</b>	<b>\$119.99</b>	<b>\$119.99</b>	<b>\$119.99</b>	<b>\$119.99</b>	<b>\$119.99</b>	<b>\$119.99</b>

\*\*Second carbide can be added to ski by drilling marked additional holes.  
Note: The use of aggressive skis, ski carbide runners or studs will alter the handling of your snowmobile, particularly in terms of manoeuvrability, acceleration and braking. Please refer to your Operators Guide for more details.

# TECH FOCUS SKIS & CARBIDES

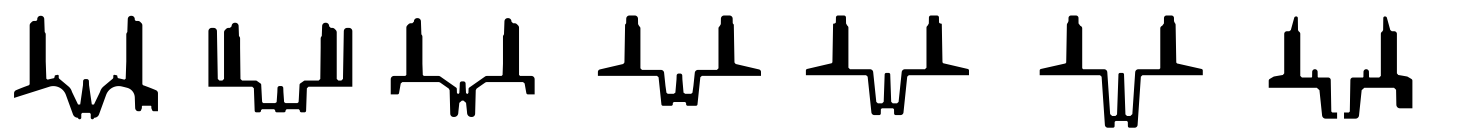

- Pilot 5.7**  
Standard on many models. Lightweight dual-keel design offers great balance between steering effort. A runner is standard on the center keel and a second runner can be added to the outside keel to reduce darting. For most trail riders, this is a great choice.
- Pilot 5.7 SL**  
Straight Line delivers light steering effort with less darting. Perfect for touring applications or smaller riders.
- Pilot 5.7R**  
Standard on the MXZ X 600RS race sled. Very aggressive single keel design provides very positive steering - for aggressive riders only.
- Pilot DS**  
Designed specifically for deep snow riding. Works well in many off trail applications from utility sleds to mountain sleds for all types of riders. Thin edge grabs sidehills well.
- Pilot DS-2**  
An evolution of the Pilot DS with a deeper and shorter center keel for deep snow applications. This version offers increased agility and less turning effort than the original. Standard on mountain sleds with 2.5" lug tracks and utility sleds, this ski is great for all around use for all types of deep snow riders.
- Pilot DS-3**  
Deep snow ski designed to match the latest 3" lug and longer tracks. Matches up well with aggressive riders using the biggest tracks.
- Pilot TS Adjustable**  
The ultimate trail solution offering adjustment with the turn of a knob. Fits all riding styles except deep snow. Revolutionary design enables you to dial in ski bite instantly for changing conditions or your riding style. The thin runner adjusts 1/2" (12.5 mm) up and down to find your sweet spot. Square shape of keel aids in preventing darting.

Skis make all the difference in getting your sled to handle just how you like. We offer seven different styles of skis for you to choose from. Which one is right for you? Here's some tips on choosing the right one:

## CHOOSING CARBIDE SKI RUNNERS

When choosing carbide runners you need to know your end game: is it more grip on icy surfaces, longer wear before replacing, or balancing the traction you added with studs?

- Carbide runners generally have three shapes of sharp carbide inserts brazed into a host bar, and the host bar can be different diameters (7/16", 1/2") and/or shapes.
- The next variable is the amount/length of carbide used. The most common lengths are 4, 6, 8 and 10 inches.
- If that same Renegade has studs, you would want more carbide to balance the added push of the track, so 8" of 60° turning carbide would work well.
- Running 10" of 60° turning carbide would deliver much more steering bite, but the steering effort goes up and your arms might feel it at the end of a long ride.
- There are no hard and fast rules for carbide choice - it's individual taste and you might have to experiment to get the handling just right.
- Flat carbide inserts are for long life. They preserve the host runner but don't add grip.
- 90° turning carbide inserts are the most common trail carbide inserts.
- 60° turning carbide inserts are much sharper. These are more aggressive - many choose these for trails.
- Other options include specialty carbides for things like ice racing.

### SKI SKIN

- Provides additional flotation and reduces ski wear.
- Made of durable polyethylene.
- Sold in pairs.

**Pilot 6.9 skis**  
860200422 • Black  
**\$134.99**

### PILOT DS SKI LINER

- Provides additional flotation and reduces ski wear.
- Same durable material as DS Ski.
- Sold in pairs.

**Pilot DS**  
860200636  
**Pilot DS-2 skis**  
860201040 • Black  
**\$154.99**

### SKI HANDLE

- High-density colored polyethylene loops.

**Pilot 5.7, 6.9, Precision, Flex, Mountain, Pilot TS**

- 505070917 • Yellow
- 505070963 • Black
- 505071032 • Blue
- 505071038 • Scarlet Red
- 505071048 • Orange Saturn
- 505071059 • Viper Red
- 505071556 • Full Moon
- 505072102 • White
- 505073642 • Sunburst Yellow
- 505073649 • Race Orange

**Pilot DS, DS-2, DS-3**

- 505072976 • Black
- 505073107 • Yellow
- 505073108 • White
- 505073388 • Lava Red
- 505073513 • Orange Crush
- 505073651 • Race Orange
- 505073665 • Sunburst Yellow

**Pilot R**

- 505071674 • Yellow
- 505073138 • Black

**\$24.99**

\*See Ski Handle Rivet Kit on page 164.



### PILOT TS CONVERSION KIT

- Upgrade to the revolutionary adjustable Pilot TS skis.

**For vehicles with 2016 RAS 2 spindle**

- For 2016 and up REV-XS models with RAS 2 or previous vehicles with 42" RAS 2 upgrade kit and 2016 spindle (860201241).
- REV-XS 2016 and up with RAS 2, REV-XP, REV-XR, REV-XS with 42" RAS 2 and 2016 spindle (860201241 or 860201353).

**860201237 • Black**  
**\$559.99**

**NEW** REV (G4)  
860201484 • Black  
**\$559.99**



### PILOT TS CONVERSION KIT WITH SPINDLES

- Pilot TS adjustable ski kit for 2015 and prior sleds equipped with RAS 2 front suspensions.
- Includes new spindles, both skis and necessary hardware.
- REV-XS 2015 with RAS 2 front suspension.
- REV-XS, REV-XP, REV-XR equipped with RAS 2 suspension and 2015 spindle (860201154).

**For vehicles with 2015 RAS 2 spindle**  
860200692 • Black  
**\$649.99**

### PILOT TS CARBIDE RUNNER

- For Pilot TS adjustable ski.
- Sold in pairs.
- Patent pending US20150314800A1.

**Pilot TS (stock replacement)**  
860201178 • Black • 5" 90° carbides  
**\$104.99**

**Pilot TS**  
860201240 • Black • 7" 60° carbides  
**\$129.99**

**NEW**

### PILOT TS CARBIDE RUNNER

- Increase front end bite with an extra 1/4" (6 mm) of runner depth, plus 7" of 60° carbide.

**Pilot TS**  
860201364 • Black • 7" 60° carbides  
**\$129.99**

## ADJUST HANDLING FOR CONDITIONS INSTANTLY

Pilot TS skis change steering bite fast and easy. It's like having 5 different size carbides to choose with the twist of a knob. (Patent Pending US20150314800A1)



**SKI-DOO PILOT\***  
Skis and carbides to suit all riding styles.

**PILOT 5.7 SKI UPGRADE KIT**

- Complete kit for upgrading earlier snowmobile models.
- Includes 2 skis, 2 handles with rivet kit, 2 Expedition carbides and all required hardware.

REV. ZX, RF  
860200524 • Black  
**\$254.99**



**NEW**

**PILOT DS-2 SKI KIT**

- Complete kit includes 2 ski assemblies with pre-installed handles, 2 Expedition carbides and all required hardware.

860201487 • Black  
**\$289.99**



**PILOT EXPEDITION CARBIDES**

REV-XP, REV-XR, REV-XU Tundra, REV-XS, REV-XM  
860201044 • Square - Pack of 2  
**\$64.99**  
860511900 • Round 7/16" - Pack of 2  
**\$69.99**



**PILOT EXTREME CARBIDES**

REV-XP, REV-XR, REV-XU Tundra, REV-XS, REV-XM  
860201043 • Round 1/2" - Pack of 2  
**\$69.99**  
860201045 • Pack of 4  
**\$139.99**



Note: The use of aggressive skis, ski carbide runners or studs will alter the handling of your snowmobile, particularly in terms of manoeuvrability, acceleration and braking. Please refer to your Operators Guide for more details.  
\*Protected under patent numbers US 7,413,198, US 7,389,995 and CA2535565.

**CARBIDES** Replacement for XP, XR, XU Tundra, XS, XM and (G4).

	EXPEDITION	EXTREME
<b>TOURING</b>	PILOT 5.7 SL (2 carbides/ski)	860201045 (pack of 4)
<b>TRAIL SPORT / PERFORMANCE</b>	PILOT 5.7 (1 or 2 carbides/ski)	N/A
<b>PERFORMANCE</b>	PILOT 5.7R (1 carbide/ski)	860201043 (pack of 2)
<b>MOUNTAIN PERFORMANCE</b>	PILOT DS, PILOT DS-2, PILOT DS-3 (1 carbide/ski)	N/A



**SKI-DOO BY *wooly's***  
Carbides

**DID YOU KNOW** Ski-Doo invented and patented the ski carbide in 1973.

**CARBIDE RUNNER**

- The Dooly<sup>®</sup> by Woollys has two 7/16" Flat-Top<sup>®</sup> runners mounted on a plate for each ski.
- Four contact lines on snow surface help decrease darting of sled as it makes own groove in a trail.
- When in a turn, only one of the Dooly bars is in contact with the snow or ice.
- A Dooly with 4", 6" or 8" of carbide on both runners provides the same turning power as a single runner with 4", 6" or 8" of turning carbide.
- Sold individually.

Pilot Skis, except DS & DS-2

860200443 • Preformed 4" 60° **\$59.99**    860200513 • Preformed 6" 60° **\$69.99**    860200514 • Preformed 8" 60° **\$94.99**



**TRAIL BLAZER IV<sup>+</sup> CARBIDES**

- 1/2" round preformed material swedged at each end to best fit ski contour.
  - With 6" of 60° turning carbide, this runner is designed for trail riders looking for performance in cornering power and control.
  - Pack of 2.
- REV (G4), REV-XP, REV-XR, REV-XU Tundra, REV-XS, REV-XM  
860200579  
**\$79.99**

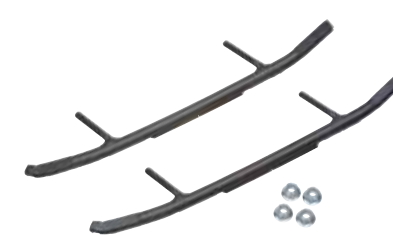

**EXTENDER TRAIL III<sup>+</sup> CARBIDES**

- 1/2" round preformed material swedged at each end to best fit ski contour.
  - 4" of 60° turning carbide provides positive cornering control.
  - Pack of 2.
- REV (G4), REV-XS, REV-XM, REV-XP, REV-XR, REV-XU Tundra  
860200578  
**\$69.99**



**EXECUTIVE<sup>+</sup> CARBIDES**

- 1/2" round preformed material swedged at each end to best fit ski contour fitted with 8" of 60° turning carbide.
  - Performance trail riders are known to use this runner.
  - Provides proper balance with a studded track.
  - Pack of 2.
- REV (G4), REV-XP, REV-XR, REV-XU Tundra, REV-XS, REV-XM  
860200580  
**\$99.99**

YOUR SLED IS THE SUM OF ITS PARTS.  
**MAKE EVERY ONE COUNT  
 BY USING ONLY  
 GENUINE  
 BRP PARTS.**



## WHY YOU SHOULD USE GENUINE BRP PARTS



Don't take a chance with your valuable Ski-Doo snowmobiles – when replacing parts, use only genuine BRP parts.

BRP parts take into account the complete vehicle and its performance - protecting our reputation and your valuable investment.

BRP parts are manufactured to our original equipment standards for materials, finish and fit.



### BRP PARTS UNDERGO RIGOROUS TESTING, INCLUDING:

- Physical field testing
- Extended wear testing
- Laboratory testing
- Harsh environment and element testing
- UV and exposure testing

With BRP parts, you get the peace-of-mind of a **FULL ONE YEAR WARRANTY**. That's whether they're installed by you or your authorized BRP dealer.



And if they're installed by your dealer, labor is covered, too.

BRP rebuilt components are cost-effective and time-saving solutions. BRP rebuilt parts carry the same one year warranty for major assemblies like short blocks, cylinders and crankshafts.



## THE NSK ADVANTAGE

Designed, developed, validated and manufactured to the highest standard in conjunction with BRP, NSK bearings feature technologies to ensure extended bearing life and uncompromising performance in extreme conditions.

### Proven results:

- Double contact seal design provides winter-grade, trouble-free environmental protection.
- Non-metallic cage reduces the risk of internal corrosion due to moisture ingress.
- Grease retains optimum performance with high water resistance in extreme temperatures.
- Increased capacity, speed and bearing life derived from real winter-grade internal design.

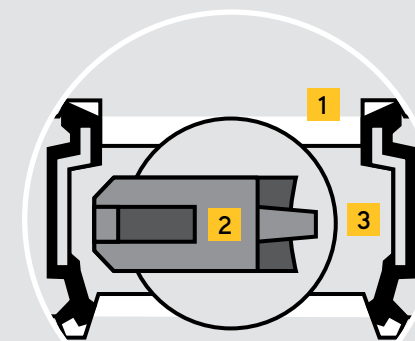

- 1** Vacuum degassed steel
- 2** TX1 polyamide cage
- 3** Double contact seal



**NEW**  **TUNNEL ICE SCRATCHERS WITH REPLACEABLE TIPS**

- New more efficient design featuring replaceable carbide tips.
  - Provide additional cooling in hard and icy conditions.
  - Coil design allows reverse operation without damage.
- REV (G4) MXZ, REV-XS, REV-XP, REV-XR with tMotion suspension 120", 129" & 137"**
- Bracket (860201503) required for MXZ with quick-adjusters.

860201430  
 REV (G4) Summit, REV-XM  
 860201279  
**\$104.99**



**NEW** **ICE SCRATCHERS TIPS**

- Ice scratcher replaceable carbide tips.

**REV (G4)**  
 860201447 • Flat shape  
 860201446 • Delta shape  
**\$34.99**

 **RAIL ICE SCRATCHERS**

- Provides additional lubrication in hard and icy conditions.
- Rail mounted, small, light.
- Design expands on coil concept to allow reversing without damage.
- Easily stored when not in use.

**REV (G4) Summit, REV-XM, REV-XP Summit**  
 860201140  
**\$84.99**



 **TUNNEL ICE SCRATCHERS**

- Provide additional cooling in hard and icy conditions.
- Double coil allows use in reverse.
- Can be stored along the tunnel when not in use.

**REV-XM, REV-XP Summit**  
 860200444  
**REV-XS, REV-XP, REV-XR with tMotion suspension 120", 129" & 137"**  
 • Bracket (860201503) required for MXZ with quick-adjusters.  
 860201107  
**\$84.99**

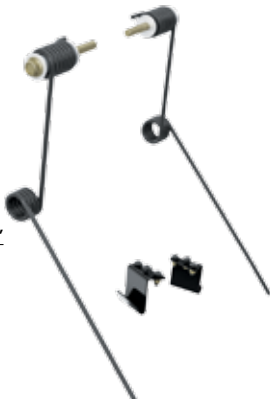

 See how these unique ice scratchers work.  
[www.ski-doo.com/genuine-parts-accessories-riding-gear/catalog-video](http://www.ski-doo.com/genuine-parts-accessories-riding-gear/catalog-video)

 The compact design reduces weight while delivering superior performance, and works in reverse.



-  **tMOTION ADJUSTABLE LIMITER**
- Quickly change limiter strap length by flipping a lever, to tune ride and handling to snow conditions and terrain.
  - Shortening keeps the front end lower and improves track approach angle.
  - Longer increases transfer and lifts the front end higher.
  - Adjustment is equivalent to 2 holes on a conventional strap (1.3"/34 mm).
  - Slim, non-intrusive design.
  - 2 initial settings to choose from: holes 3 to 5 or 2 to 4 (compared to conventional strap hole positions).
  - US patent 9022156.

**NEW**

**REV (G4)**  
 860201492 • Black  
**REV-XM 2016**  
 For REV-XM 2015 and prior: tMotion Adjustable Limiter Retrofit Kit is required (860201349)  
 860201105 • Black  
**\$149.99**

 See how the t-Motion Adjustable Limiter change handling in seconds.  
[www.ski-doo.com/genuine-parts-accessories-riding-gear/catalog-video](http://www.ski-doo.com/genuine-parts-accessories-riding-gear/catalog-video)

**tMOTION ADJUSTABLE LIMITER RETROFIT KIT**  
 (Not illustrated)  
 • Includes new front arm and all the parts and features of the 860201105 kit.  
**REV-XM 2015 & prior**  
 860201349  
**\$219.99**

**tMOTION ADJUSTABLE LIMITER REPLACEMENT PARTS KIT**  
 (Not illustrated)  
 860201426  
**\$44.99**

**ARTICULATED REAR SUSPENSION (REV-XM)**

- Two modes: Articulation, locked down.
- Improves reverse performance in soft snow conditions.
- Includes new rails and all hardware.

**Fits both tMotion and SC-5M**

860201223 • 154" Black/Aluminum	860201163 • 163" Black/Aluminum	860201236 • 174" Black/Aluminum
<b>\$499.99</b>	<b>\$599.99</b>	<b>\$599.99</b>



 **DID YOU KNOW** The Articulated Rear Suspension is inspired by the go-anywhere performance of the SC-5U on Skandic, Tundra and Expedition sleds.

 Watch the new Articulated Rear Suspension in action.  
[www.ski-doo.com/genuine-parts-accessories-riding-gear/catalog-video](http://www.ski-doo.com/genuine-parts-accessories-riding-gear/catalog-video)



 You can have it all. The Adjustable Limiter Strap offers mountain riders the opportunity to easily perform handling adjustments simply by flipping a lever. Measurably change weight transfer and ski pressure quickly and effortlessly.



**NEW**

**FOX FLOAT 3 SHOCKS**

- New calibration Fox Float 3 Shocks specifically for REV (G4) Summit.
- Lighter than coil spring shocks.
- Infinitely adjustable main air chamber pressure.
- IFP (Internal Floating Piston).
- Advanced high-flow velocity-sensitive damping.
- Fully rebuildable and revalveable.
- Comes with Fox air pump for pressure adjustment.
- Sold in pairs.

REV (G4) Summit

860201278

**\$799.99**

**MAINTENANCE KIT FOR DRIVE PULLEY**

- Includes: 1 Spring Cover Ass'y, 3 Rollers Ass'y, 1 Bushing (Siding Flange), 6 Slider Shoes, 6 O-Rings, 1 Circlip, 3 Cotter Pins & 3 Lever Axles.

REV-XM, REV-XU

415129625 • 2012 (1200)  
2012 to 2017 (600 E-TEC high altitude)  
2013 to 2017 Tundra Xtreme

**\$119.99**

REV-XP, REV-XS, REV-XM, REV-XU

415129626 • 2011 to 2017  
(800R P-TEK & 800R E-TEC)  
415129627 • 2008 to 2010  
(800R P-TEK & 800R E-TEC)

415129708 • 2011 and prior (1200),  
2011 and prior (600 E-TEC high altitude)  
**\$119.99**

REV-XP, REV-XR, REV-XS,  
REV-XM, REV-XU

415129624 • 2011 (550F)  
2011 to 2017  
(600 & 600 E-TEC Sea-Level)

**\$119.99**



**MAINTENANCE KIT FOR DRIVE PULLEY**

- (Not illustrated)
- Includes: 6 rollers ass'y, 2 slider shoes, 3 O Rings.

All models with eDrive 2 Clutch

415130055

**\$104.99**

**eDRIVE 2 CLUTCH**

- With double the number of rollers and arms compared to TRA designs, this clutch is designed for low maintenance and long life with 4-stroke powertrains.

4-TEC 1200 only (2010 and up)

415129789

**\$499.99**



**SWAY BAR QUICK DISCONNECT LINK KIT**

- Kit allows you to utilize the benefits of a sway bar on rough trails, and quickly disconnect it for sidehilling the mountains.
- Sold individually.

REV-XM, REV-XP Summit 2013 and up

860200811

REV-XP Summit 2012 and prior

860200667

**\$69.99**



**FOX FLOAT SHOCK GUARDS**

- Protection for Fox Float 3 shocks.
- Protect shock body from root and brush damage.
- Sold in pairs with mounting hardware.

Fox Float 3 shocks

860201011 • Black

**\$24.99**

**FLOATING QRS SHORT SHAFT CONVERSION KIT**

- Conversion kit allows installation of a removable floating secondary pulley.
- Also provides ability to remove driven pulley without removing countershaft.
- Includes gun-drilled lightweight shaft and all necessary parts and hardware for conversion.

Fits 600 CARB, 600 E-TEC, 800 P-TEK and 800 E-TEC engines

860200832

**\$449.99**



**QRS TECH LINK**

- Designed for extreme use, this lightweight fully adjustable carbon fiber support helps maintain the driven pulley position through the most extreme loads.
- Mounts conveniently between the front bulkhead and secondary tower.

REV-XM, REV-XS, REV-XP except 550 Fan and 4 stroke engines

860200783

**\$214.99**



Kit 36"



42" with shocks



42" without shocks

**FRONT SUSPENSION KIT**

36"

- To update your sled to the REV-XM Summit X with T3 package.
- Delivers the agility of the original S-36 handling package, plus the benefits of the RAS 2.
- Lighter weight.
- Better straightline tracking on big bumps.
- Great styling.
- HPG shocks.
- Ski stance adjustable from 35.7" (90 cm) to 37.4" (95 cm).

REV-XM, REV-XS, REV-XP

860201153 • Black

**\$799.99**

42" with shocks

- To update your sled to the RAS 2, X-package configuration.
- 42" (107 cm) RAS 2 front suspension kit.
- Updates sleds to latest REV-XS trail front end.
- Better straightline tracking on big bumps.
- Lighter weight.
- Great styling.
- HPG Plus R shocks with rebound adjustment.
- Includes spindle compatible with Pilot TS ski.

REV-XM, REV-XS, REV-XP without 42" front suspension

860201353 • Black

**\$799.99**

42" without shocks

- Includes spindle compatible with Pilot TS ski.

REV-XS, REV-XP, REV-XR with 42" front suspension

860201241 • Black

**\$539.99**



**DRIVEN PULLEY CAM FOR QRS ROLLER SECONDARY CAM**

- Specially designed for the QRS driven pulley.
- For optimal smooth performance and durability.

REV-XP

417126956 • 40°  
417126962 • 38°  
417126974 • 44-40°  
417126975 • 44-33°

417127325 • 44-42°  
417127367 • 44°  
417127372 • 42°  
417127426 • 46-42°

**\$109.99**

**NEW**

**pDRIVE™ CLICKER KIT**

REV (G4) MXZ

860201435

**\$79.99**



**SEA LEVEL CALIBRATION CLUTCH KIT**

Please refer to high altitude / sea-level specification bulletin to find the appropriate clutch kit and components for your vehicle.



**CVT COOLING SYSTEM**

- Ensures superior air flow to reduce belt temperature by 45 °F / 25 °C.
- Note: For 2008, part 417300448 is required for installation.

REV-XP, except 2008

860200883

**\$54.99**



**NEW OWNER START-UP KIT**

- Includes 1 drive belt, 2 spark plugs, 1 gallon of XPS 2-stroke oil and 1 quick fix detailing kit (XPS spray cleaner and polish with two XPS microfiber towels) in a convenient box ready to go.

<b>600 E-TEC</b>	<b>800 E-TEC</b>
415129543	415129547
<b>\$199.99</b>	<b>\$244.99</b>



**PISTON KIT**

- Kit includes: piston, rings, piston pin, needle bearing and circlips.

<b>415129406 • 593 HO including SDI</b>
<b>\$189.99</b>

- 415129405 • 793 HO
- 415129854 • 800 E-TEC 2011 and prior
- 415129855 • 800 E-TEC 2012 and up
- 415129858 • 800R P-TEK and 800R E-TEC 2010

**\$229.99**

- 415129542 • Ski 552
- 415129541 • Ski 593

**\$199.99**



**FUEL TANK CONVERSION KIT**

- 10-gallon (38-liter) full size fuel tank kit for converting vehicles with 5-gallon racing fuel tank.
- All necessary hardware for installation included.

**REV-XP & REV-XS with racing fuel tank (5-gallon)**

860200936  
**\$394.99**



**OIL FILTER**

- Use on all Ski-Doo engines.
- See your dealer for details.



**NGK® SPARK PLUG**

- You'll see a difference with genuine NGK spark plugs.
- Solid steel terminal reduces the chance of arcing in the plug cap, which may interfere with electric component.
- A necessity in today's ignition systems.

<b>415129429 • 1200 4-TEC - CR8EKB</b>	<b>415129375 • 600 H.O. E-TEC - PZFR6F</b>	<b>415129944 • 900 ACE - MR8B18</b>
<b>\$9.99</b>	<b>\$19.99</b>	<b>\$21.99</b>
<b>512059552 • 550F, 600RS - BR9ECS (Gap 0.5 mm)</b>	<b>415129670 • 600 ACE - MR7B18</b>	<b>415128524 • 600 CARB &amp; 800 P-TEK - BR9-ECS (Gap 0.8 mm)</b>
<b>\$6.99</b>	<b>\$21.99</b>	<b>\$8.99</b>
<b>512060029 • 600 CARB, 800R P-TEK - BR8ECS (Gap 0.8 mm)</b>	<b>415129484 • 800R E-TEC - PFR7AB</b>	<b>414961100 • BR9-ES</b>
<b>\$8.99</b>	<b>\$19.99</b>	<b>\$2.99</b>



**✓ DID YOU KNOW** It's always good to carry a spare OEM belt and spark plugs on every ride.

**PERFORMANCE DRIVE BELTS**

- High performance drive belts calibrated to maximize your sled's performance.
- Aramid tensile cords used in construction for extra long life and dependability, also delivers a consistent length with minimal belt shrinkage and minimal length adjustments.
- High tensile reinforced fiber elastomer undercords provide minimal dusting and long term flex life.
- Flexweave overcord for superior adhesion and crack resistance.
- Consistent performance during life of belt.
- Quality you can count on for optimum performance.
- Built with distinctive durability features for mountain, trail or fast tracks.

SKU	DESCRIPTION	PRICE
<b>REV-XP, REV-XR, REV-XU, REV, REV-XM, REV-XS, REV (G4)</b>		
417300383	600 E-TEC, 800R PowerT.E.K except Summit, 1200 4-TEC and 900 ACE	<b>\$129.99</b>
417300391	850 E-TEC, 800 E-TEC and Summit 800R PowerT.E.K	<b>\$184.99</b>
417300197	600 CARB, 600, 600 H.O SDI	<b>\$104.99</b>
417300367	550 Fan (2010-2011)	<b>\$59.99</b>
415060600	Fan (2009 and prior)	<b>\$59.99</b>
414860700	550 Fan (2012, 2014)	<b>\$59.99</b>
417300127	600 ACE	<b>\$104.99</b>
<b>RT</b>		
417300189	1000	<b>\$174.99</b>
<b>ZX</b>		
414860700	500, 600 LC	<b>\$59.99</b>
417300127	700, 800 LC	<b>\$104.99</b>
417300067	700 (1999, 2000)	<b>\$104.99</b>
415060600	Fan	<b>\$59.99</b>
417300197	V-1000, 600 SDI (2004), V-800	<b>\$104.99</b>
417300383	800 SDI (2004)	<b>\$129.99</b>
<b>SKANDIC</b>		
605348425	All 2008 models, 2007 TUV and SWT V-800	<b>\$119.99</b>
414633800	All Fan Skandic except Tundra	<b>\$59.99</b>
417300326	Tundra RF 300	<b>\$79.99</b>
415060600	Tundra RF 500	<b>\$59.99</b>
417300197	Tundra RF V-800	<b>\$104.99</b>
414827600	Old Tundra 280 Fan	<b>\$59.99</b>
<b>S-CHASSIS</b>		
417300067	Semi-cogged	<b>\$104.99</b>
414860700	Not cogged	<b>\$59.99</b>

**TECH FOCUS**

**DRIVE BELTS**

The drive belt is an integral part of your snowmobile's transmission and its importance for achieving its maximum performance can't be overstated. All the tuning or changes made in gearing, weights, ramps and springs in the world don't matter if the belt can't consistently maintain its performance.

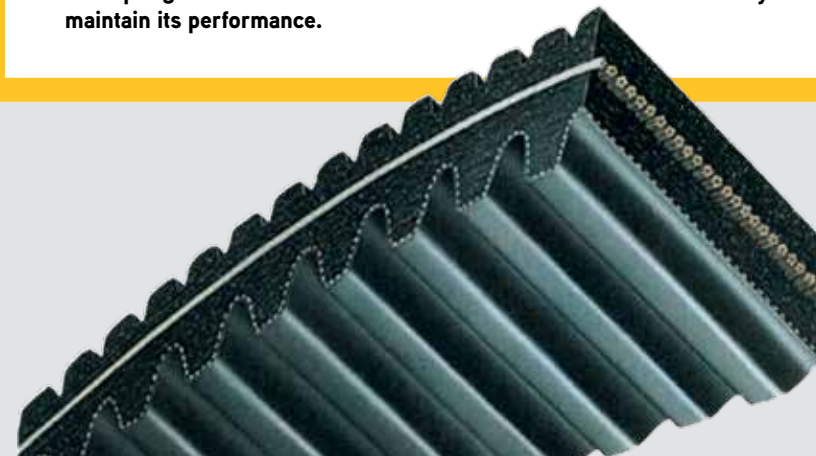

**SO, WHAT MAKES A BELT A BELT?**

You see that several elements include "Aramid." Aramid is a man-made fiber resistant to heat and abrasion and is used to add strength and long life to the rubber belt. Aramid fibers and fabrics are common in belts.

**Top Cog with Special Aramid Fiber**

**Adhesion Rubber**

**Specialized High Modulus Aramid Cord**

**Compressive Rubber with High Modulus PBO Fiber**

**Bottom Cog with Aramid Fabric**

**BRP BELT CONSTRUCTION VS. COMPETITORS**

	Brand A	Brand A C12	Brand B	BRP
<b>Top Rubber Chopped Fiber</b>	CR Aramid	CR Aramid	H-NBR Aramid/Cotton	CR Aramid
<b>Upper Adhesion Rubber Chopped Fiber</b>	CR	CR	H-NBR	CR
<b>Cord</b>	Aramid	Carbon	Aramid	Aramid
<b>Lower Adhesion Rubber Chopped Fiber</b>	CR	CR	H-NBR	CR
<b>Bottom Rubber Chopped Fiber</b>	CR Aramid	CR Aramid	H-NBR Aramid/Cotton	CR/PBO Aramid
<b>Bottom Fabric</b>	Acrylic 1ply	Acrylic 1ply	CR Aramid/Cotton	Aramid/PET 1ply

CR: Chloroprene Rubber

**MODULUS & TENSILE STRENGTH**  
(Based on BRP Dynamometer Testing)

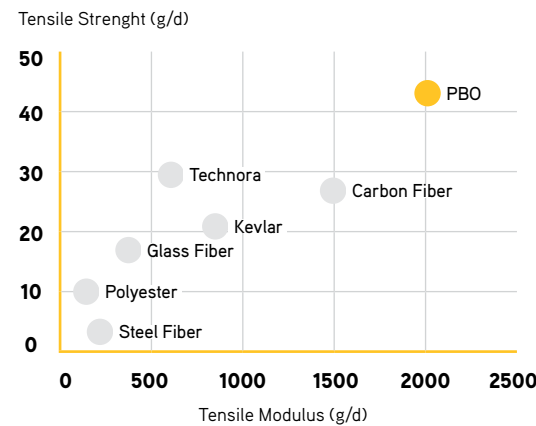

**DURABILITY COMPARISON**

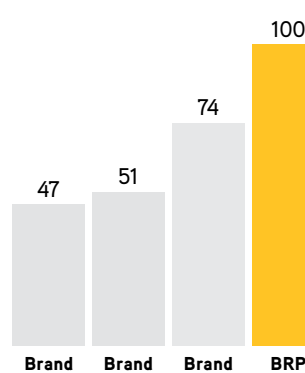

**USE THE RIGHT BELT**

Just as we calibrate our clutches and gearing to deliver the best possible performance for how a sled is ridden, we specialize the belt for the application, too.

Different types of riding create different heat and load conditions our engineers must account for. For instance, higher drivetrain loads, like on a Summit sled churning 3 in. paddles on the throttle hard for extended periods of time, generally require belts with a stiff construction and high heat resistance. A utility sled pulling equipment or heavily loaded sees high drivetrain loads too, but the clutch calibrations, engine RPM, vehicle speed and environment differ significantly – so will the required belt.

This is why it's best to match the exact model and year of your snowmobile to replacement belt. And even though BRP belts might have the same width and length dimensions, the difference in the materials delivers the best performance and longevity for your sled's application and calibrations.

**REAR SUSPENSION NSK WHEEL BEARING**

- High performance grease developed for extreme temperatures, water resistance and high speeds with low start torque.
- Advanced Winter Grade DUL1 double-contact seal design for optimum protection from moisture and contamination.
- Polyamide resin ball-guide cage facilitates smooth rolling contact and lubricant distribution.
- Ultra-clean steel for extended bearing life - High-grade balls for quiet and smooth operation even at high speed.
- Super finished raceways to minimize noise and improve lubricant distribution and life.

<b>NSK 6004</b>	<b>NSK 6205</b>	<b>NSK 6005</b>	<b>NSK 6006</b>
503190396	293350115	503191982	503191778
<b>\$7.99</b>	<b>\$7.99</b>	<b>\$9.99</b>	<b>\$9.99</b>

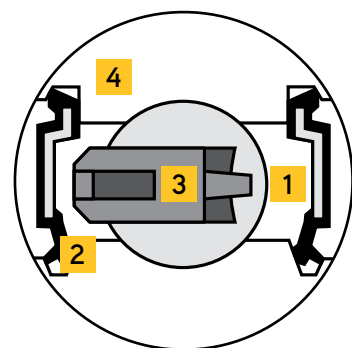

VS

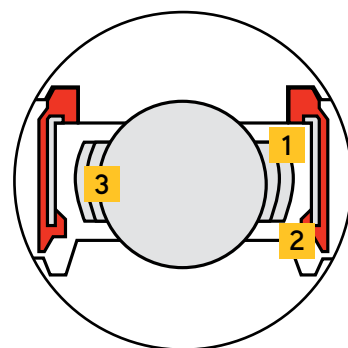

**GENUINE BRP BEARING**

- EXCLUSIVE TO BRP**
- HIGH PERFORMANCE SYNTHETIC GREASE**  
High performance grease developed for extreme temperatures, water resistance and high speeds with low start torque.
  - DUL1 DOUBLE-CONTACT SEAL DESIGN**  
Advanced Winter Grade DUL1 double-seal design for optimum protection from moisture and contamination.
  - T1X CAGE**  
Polyamide resin ball-guide cage facilitates smooth rolling contact and lubricant distribution.
  - PREMIUM CONSTRUCTION**
    - Ultra-clean steel for extended bearing life.
    - High-grade balls for quiet and smooth operation even at high speed.
    - Super finished raceways to minimize noise and improve lubricant distribution and life.

**GENERIC BEARING**

- GENERIC INDUSTRIAL GREASE**
  - Grease optimized for industrial use.
  - Rarely suitable for snowmobiles.
- GENERIC SINGLE LIP SEAL DESIGN**
  - Lip design not optimized to prevent water from entering.
  - Poor water resistance when loading.
- INDUSTRIAL STEEL RIVETED CAGE**
  - Standard industrial style not optimized for snowmobiles.
  - Metallic cage presents higher risk of corrosion when used in harsh environments.

**BRP ENGINE REBUILD CENTER**

Experienced BRP technicians use only new, original Rotax parts — there's no cutting corners and reusing parts that "look good." For instance, when rebuilding a crankshaft, ALL bearings, rods, pins and seals are replaced, regardless of condition.

Rebuilt short blocks get new pistons, rings, gaskets, crankshaft rods, pins, bearings and seals - every wear item is replaced with new genuine Rotax parts.

The BRP Rebuild Center has been providing this service to dealers and consumers for more than 30 years.



**DID YOU KNOW**  
BRP has a Rebuild Center for snowmobile engines, short blocks, cylinders and crankshafts. Available from your dealer, rebuilt parts come with a one year warranty and save you significant money.



**NEW**

**USB POWER OUTLET KIT**

- Provides clean, stable power to recharge your electronics while riding.
- Dual USB ports.
- Plug-and-play installation.
- Includes wiring harness.

REV (G4)  
860201261  
**\$44.99**



**12-VOLT POWER OUTLET KITS**

- Power up all your electronics with easy to mount 12V plug.
- Install inside storage compartment.
- Wiring harness included.

**NEW**

REV (G4)  
860201423  
**\$39.99**

REV-XM, REV-XS  
860200632

REV-XP, REV-XR, REV-XU Tundra  
(except standard 2011-2012)

860200196  
**\$29.99**

All models with battery (except REV-XM, REV-XS, REV-XP, REV-XR, REV-XU Tundra)

861507200  
**\$24.99**

**REAR 12-VOLT POWER OUTLET**

- (Not illustrated)
- Mounts inside rear seat storage compartment.
  - Wiring harness included.

Fits REV-XU Skandic & Expedition models without E-TEC engine  
860200979  
**\$34.99**



**DID YOU KNOW** All Ski-Doo 4-stroke engines use Learning Key technology, with two dealer-programmed top speeds and 5 acceleration rates.



**LEARNING KEY (PROGRAMMABLE)**

- Ask your dealer to program you a spare key.
- 2015 and up vehicles with 600, 900 ACE or 1200 engine
- 860201162 • Green
- 2014 vehicles with 900 ACE engine
- 860200907 • Green

**\$49.99**



**RF DESS™ CORD**

- Ask your dealer to program you a spare key.
- 515177457  
**\$54.99**



**DESS CORD**

- Ask your dealer to program you a spare key.
- 515177057  
**\$39.99**

**HEATED VISOR KIT**

- Easy install plug-in for visor kit or heated bags.
- Wiring harness included.

**NEW**

REV (G4)  
860201283  
REV-XP, REV-XR, REV-XU Tundra,  
REV-XM, REV-XS  
860201234  
**\$34.99**



**3W HEATER FOR BAGS**

- Replacement or additional heater for heated bags.

515176786  
**\$19.99**



**HEATED PASSENGER VISOR KIT**

- Enjoy fog-free riding with this visor kit option for your 1 + 1 Seat.
- To be used in conjunction with Heated 1 + 1 Grip with Guard (860200584).

860200882  
**\$39.99**



**RCA ADAPTOR PLUG KIT**

- Y plug power splitter lets you connect 2 heating components or 1 heater and 1 electrical visor.

515176794  
**\$10.99**

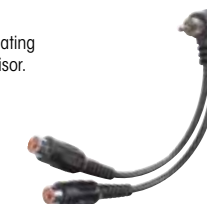

**ELECTRIC ACCESSORIES Y-ADAPTOR**

- Harness enables use of more than one plug-and-play accessory.
- Required when using more than one of either of these accessories: Signature LED Light for Handguards, GPS, Ambient Air & Engine Temperature Module.

REV-XP, REV-XR, REV-XU  
860201141  
**\$39.99**



**ELECTRIC ACCESSORIES WIRING HARNESS**

- Electrical kit required when combining multiple accessories.

REV-XS, REV-XM, REV-XP, REV-XR, REV-XU Tundra  
(except Tundra Standard 2011-2012)  
860200817  
**\$39.99**



**DID YOU KNOW** Like most BRP accessories, the Ambient Air & Engine Temperature Module is truly plug-and-play for no-hassle installation.



**AMBIENT AIR & ENGINE TEMPERATURE MODULE**

- Get both outside air and engine temps on your cluster.
- Fits both analog and digital multifunction gauge.
- Bonus feature: Lap record mode on multifunction gauge.
- Plug-and-play in vehicle harness.

2015 and up for all platforms (except fan-cooled engines and 2015 P-TEK)

860201021

**\$144.99**

**NEW**

REV (G4)

860201362

**\$154.99**

Know the temperature outside and in your engine. Perfectly integrated within the gauge this module delivers both.



Analog engine temperature



Engine temperature

**ENGINE TEMPERATURE MODULE**

- Easy plug-and-play into existing gauge cluster.
- Module plugs into the wire harness and activates the function on the gauge.
- Fits on REV-XP, REV-XR, REV-XS, REV-XM, analog and multifunction gauges.
- Activates engine temperature display.
- Activates engine temperature display and lap record mode on 2013-2014 REV-XM, REV-XS multifunction gauges.

2014 & prior REV-XP & REV-XU Tundra (except 550), REV-XR, REV-XM, REV-XS

860200629

**\$104.99**

**YUASA<sup>®</sup> BATTERIES**

- Maintenance free.
- No need to add water but periodic charging required when not in use.
- Absorbed Glass Mat (AGM) Separators – an advanced battery technology that eliminates the need to ever add water.
- Advanced lead-calcium technology – holds its specific gravity more than 3 times longer than conventional lead antimony batteries.

42215 • 14 Amps. Dry (12N14-3A)

**\$49.99**

296000295 • 18 Amps. Wet (YTX20HL-PW)

**\$128.99**

410301203 • 18 Amps. Wet (YTX20L-BS)

**\$115.99**

410301201 • 20 Amps. Dry (Y50N18L-A)

**\$83.99**

410922962 • 21 Amps. Wet (YTX24HL-BS)

**\$142.99**

410301204 • 3 Amps. Wet (YTX4L-BS)

**\$51.99**

515176151 • 30 Amps. Wet (Y1X30L)

**\$161.99**



**YUASA SMART SHOT AUTOMATIC BATTERY CHARGER**

- The Yuasa Smart Shot automatic battery charger is available in 1 Amp charge capacity and ensures that optimum power is available from your battery when you need it.
- Charger is supplied with a fused-ring connector, in addition to the alligator clips that can be attached permanently to your battery, making charging and maintaining your battery a snap.

Automatic 1 Amp (1000 MA) 3 stage charge cycle

529036307

**\$41.99**

**NEW**

**BATTERY COVER AND SUPPORT**

- Use in conjunction with LinQ Ergo Summit Seat Bag (860201355) or 1 + 1 Ergo Seat System (860201268) on models without a battery standard.

REV (G4)

860201407

**\$44.99**



**ELECTRIC STARTER KIT**

- Start your sled with the simple push of a button.
- Kit components vary per model.

**NEW**

REV (G4)

860201282

REV-XP 500SS, 600 Sport 2009 and up, REV-XP Fan, REV-XU Tundra

860201085

REV-XP, REV-XM, REV-XS 600 E-TEC 2009 and up, 800R, 800R E-TEC

860200627

**\$559.99**



**START YOUR SLED WITH THE SIMPLE PUSH OF A BUTTON.**



**AIR RADIATOR KIT**

- Provides addition cooling in extreme conditions.
- Note: Not compatible with Auxiliary LED Light.

REV-XR 1200 4-TEC (2015 and prior)

860200448

**\$504.99**

REV-XS & REV-XR with 600 & 900 ACE (2014 and prior & 2016 and up)

860201350

REV-XS & REV-XR with 600 & 900 ACE (2015 only)

860201186

**\$429.99**

REV-XS 1200 4-TEC (2016 and up)

860201401

**\$519.99**



**PRIMER KIT**

- Provides hassle-free starting in extreme cold temperatures.

REV-XU Tundra, 500 SS

860200416

**\$37.99**

**REWIND STARTER KIT**

- Complete rewind kit.
- Note: Rewind handle locates behind panel; instant handle access requires different side panel.

600 HO E-TEC, 800R E-TEC engines, except REV-XU Expedition, WT, SWT

860201053

**\$174.99**

**NEW**

REV (G4)

860201410

**\$164.99**



**ENGINE HEATER KIT**

- Improve starting in extreme cold temperatures.

600 ACE, 900 ACE

860201315

**\$169.99**



### LED LIGHTS



#### ADAPTOR FOR SIGNATURE LED LIGHT FOR HANDLEBAR AIR DEFLECTORS

REV-XP, REV-XR, REV-XU, except fan-cooled engines

860201114

**\$39.99**

### PROTECTION / REINFORCEMENT

#### FRAME UNDERBELLY BRACE KIT / S-MODULE REINFORCEMENT KIT

- S module reinforcement, standard on 600 RS racing sled.
- Compatible with Ski-Doo skid plates.

REV-XM, REV-XS, REV-XP, REV-XR, REV-XU Expedition

860200905 • Black

**\$39.99**



#### SKID PLATE FASTENER KIT

- (Not illustrated)
- Made to fit and hold your skid plate securely in place.

REV-XP, REV-XR, REV, RT, REV-XS, REV-XM

860200808 • Skid rivet

**\$9.99**

### SEATS, BACKRESTS / FOOTRESTS

#### LinQ 1 + 1 BACKREST ANCHOR BASE KIT

- Allows installation of LinQ 1 + 1 Backrest on more than 1 vehicle.

REV-XM, REV-XS, REV-XP & REV-XR (except GTX, Grand Touring), REV-XU Tundra

860201024 • Black

**\$174.99**



#### RUBBER LATCH FOR LinQ 1 + 1 BACKREST

- (Not illustrated)

510005617 • Left Side

510005618 • Right Side

**\$11.99**

### STORAGE / CARGO

#### LinQ REPAIR KIT

- (Not illustrated)
- Replaces LinQ mechanism.
- Included: Lever, T-lock and hardware.

860201137 • Left Side

860201138 • Right Side

**\$13.99**

#### RUBBER LATCH SERVICE KIT FOR TUNNEL LinQ ACCESSORIES

- (Not illustrated)
- LinQ Tunnel Bags and LinQ Fuel Caddy

860201057

**\$16.99**



#### LinQ CARGO BASE KIT

- Unique mounting fastener usable on any LinQ System accessory.
- Tool-less installation and removal.
- Included: 2 Cargo LinQ bases and hardware.

860200583 • Black

**\$29.99**

#### LinQ PROTECTIVE DECAL KIT

- Durable Lexan decals to protect your tunnel.
- REV-XS, REV-XM, REV-XP
- Replacement item on model year 2013, but required for utilizing the LinQ accessories on model years 2012 and prior.

860200767 • Black



REV (G4)

516007627

**\$9.99**



#### MONTANA GPS MOUNT KIT

- (Not illustrated)
- Mounting kit and hardware for Garmin Montana GPS.
- To be able to use GPS on more than 1 vehicle.

REV-XS, REV-XM

860201029

**\$104.99**

#### UNIVERSAL GPS MOUNT

- Kit includes mount, wiring harness and all hardware.
- GPS sold separately.
- Requires Montana GPS and Support Kit (860201417).

REV-XR, REV-XU

860201018 • Black

**\$74.99**



#### LinQ ADAPTOR PLATE

- Allows installation of LinQ Cargo Base on embossed REV-XU tunnels.

REV-XU Skandic WT, SWT, REV-XU Expedition SE, LE, Xtreme

860200945 • Black

**\$59.99**



### TRACTION & CONTROL

#### DRILL BIT

415128884

**\$13.99**



#### SKI HANDLE RIVET KIT

- Includes 2 long and 2 short aluminum rivets for repairing the handle on Pilot Skis.

860200525

**\$10.99**



### GARAGE



#### RATCHET TIE-DOWNS

- 400 lb (181 kg) safe working load.
- 1" x 10" (2.5 cm x 3 m) strap with Sea-Doo, Ski-Doo and Can-Am logos.
- Deluxe ratchet with rubber handle.
- Coated S hooks.
- Pack of 2.

860200447 • Black/Grey

**\$16.99**

#### SLED SHOP WHEELS

- Non-slip rubber grips allow this steel 3-dolly system to move your sled easily throughout the garage.
- Works with both dual and single runner skis.

861002600

**\$69.99**



#### SKI-DOO 2" RUBBER HITCH CAP

520001498 • Black

**\$13.99**



#### LOCKABLE VEHICLE FUEL CAP

- Lockable to protect your fuel.
- Meets latest EPA requirements.

860200387 • Black

**\$39.99**



#### COUNTER STOOL

- Stool has classic chrome legs and seat with BRP or Ski-Doo X-Team logo.

415129015 • BRP

415129292 • Ski-Doo X-Team

**\$124.99**

### STICKERS



#### SKI-DOO PERFORMANCE

516006297 • Set of 20 decals on two 10" X 8" (25 cm X 20 cm) sheets

**\$23.99**



#### SKI-DOO X-TEAM BEE

516006301 • Set of 2 decals: 11" X 6" (28 cm X 15 cm)

**\$23.99**



#### SKI-DOO X-TEAM CAMO

516006304 • Set of 6 decals on two 10" X 8" (25 cm X 20 cm) sheets

**\$23.99**



#### SKI-DOO POP STICKER SERIES

516006292 • Set of 2 decals: 10" X 8" (25 cm X 20 cm)

**\$19.99**



#### SKI-DOO TECHNO X

516006299 • Set of 2 decals: 10" X 8" (25 cm X 20 cm)

**\$14.99**



#### SKI-DOO X-TEAM KIT

516006300 • Set of 6 decals on two 10" X 8" (25 cm X 20 cm) sheets

**\$23.99**



#### SKI-DOO FREERIDE SKULLS

516006307 • Set of 3 decals: 10" X 8" (25 cm X 20 cm) sheet

**\$16.99**



#### SKI-DOO FREERIDE CAMO

516006303 • 20" X 7" (51 cm X 18 cm)

**\$26.99**



#### SKI-DOO BEE

516006302 • Set of 3 decals: 20" X 8" (50 cm X 20 cm) sheet

**\$23.99**



## RAP-CLIP COVER WITH "CLIP" ATTACHMENT SYSTEM

The strap-less snowmobile trailering cover that clips on to the tunnel intuitively with clips.

- No more kneeling in the snow.
- Easy installation.
- Installs in seconds.

### EQUIVALENT CONFIGURATION AND POSSIBLE OPTIONS

PLATFORM	STOCK MODEL (2017)	1 UP Seat	1+1 Seat 2-up	2 UP Seat	Backrest	Passenger Handgrips	Passenger Wind Deflectors	Extra Low Windshield	Low Windshield	Medium Windshield	High Windshield	Extra High Windshield	Ultra High Windshield	Mirrors on Windshield Side Deflectors	Handlebar Air Deflectors	Mirrors on Handlebar Air Deflectors	Mirrors on Side Panel	MXZ Hi-Riser Kit	Summit Hi-Riser Kit	Extra Front Bumper	Luggage Box			
REV (G4)	SUMMIT (SP, X)																					860201440	<b>\$239.99</b>	
	SUMMIT WITH MEDIUM WINDSHIELD																						860201486	<b>\$239.99</b>
	MXZ (X, TNT), RENEGADE (X, ADRENALINE)																						860201437	<b>\$239.99</b>
	MXZ OR RENEGADE WITH MEDIUM WINDSHIELD																						860201438	<b>\$289.99</b>
	MXZ OR RENEGADE WITH ULTRA HIGH WINDSHIELD																						860201485	<b>\$239.99</b>
REV-XM	MXZ OR RENEGADE WITH 1 +1 AND BACKREST																					860201439	<b>\$239.99</b>	
	SUMMIT (SP, X, BURTON), FREERIDE																						860201375	<b>\$239.99</b>
	RENEGADE (BACKCOUNTRY X)																						860201373	<b>\$239.99</b>
REV-XS	RENEGADE (BACKCOUNTRY)																						860201374	<b>\$239.99</b>
	RENEGADE (BACKCOUNTRY)																						280000625	<b>\$239.99</b>
	RENEGADE (BACKCOUNTRY)																						860201373	<b>\$239.99</b>
	RENEGADE (BACKCOUNTRY)																						860201374	<b>\$239.99</b>
	RENEGADE (BACKCOUNTRY)																						280000625	<b>\$239.99</b>
	RENEGADE (BACKCOUNTRY)																						860201373	<b>\$239.99</b>
	RENEGADE (BACKCOUNTRY)																						860201374	<b>\$239.99</b>
RENEGADE (BACKCOUNTRY)																						280000627	<b>\$239.99</b>	
REV-XP	RENEGADE (SPORT, ADRENALINE, ENDURO)																						280000626	<b>\$289.99</b>
	RENEGADE (SPORT, ADRENALINE, ENDURO)																						280000609 <sup>‡</sup>	<b>\$279.99</b>
	RENEGADE (SPORT, ADRENALINE, ENDURO)																						860201371	<b>\$289.99</b>
	RENEGADE (SPORT, ADRENALINE, ENDURO)																						860201372	<b>\$289.99</b>
REV-XU	RENEGADE (SPORT, ADRENALINE, ENDURO)																						280000630	<b>\$289.99</b>
	RENEGADE (SPORT, ADRENALINE, ENDURO)																						860201387	<b>\$259.99</b>
	RENEGADE (SPORT, ADRENALINE, ENDURO)																						860201388	<b>\$239.99</b>
REV-XU	RENEGADE (SPORT, ADRENALINE, ENDURO)																						280000566	<b>\$239.99</b>
	RENEGADE (SPORT, ADRENALINE, ENDURO)																						280000590 <sup>‡</sup>	<b>\$289.99</b>
	RENEGADE (SPORT, ADRENALINE, ENDURO)																						280000650	<b>\$239.99</b>
	RENEGADE (SPORT, ADRENALINE, ENDURO)																						280000673	<b>\$279.99</b>
REV-XU	RENEGADE (SPORT, ADRENALINE, ENDURO)																						280000649	<b>\$239.99</b>
	RENEGADE (SPORT, ADRENALINE, ENDURO)																						860201377	<b>\$239.99</b>
	RENEGADE (SPORT, ADRENALINE, ENDURO)																							

<sup>‡</sup>While supplies last.

### RACING STORAGE COVER (UNIVERSAL)

- Provides protection for any snowmobile model.
- All models
- 280000529 • Black with graphics
- \$114.99**



### SUPERGLIDE EDGE RAIL TRIM

- To secure Superglides on ramps or decks leaving an encapsulated finished edge.
- 860201217 • Aluminum
- \$69.99**



### SUPERGLIDE 2 PRO

- No more ripping up the plywood on your trailer.
- Allows skis to glide with ease.
- Traction knobs incorporated for better traction.
- Moisture minimizing venting.
- Accommodates all sleds with single or dual runner skis.
- Total length of 20 feet.
- 860201216
- \$114.99**



### SUPERTRAC KIT

- 860201413 • 12" **\$34.99**
- 860201414 • 24" **\$42.99**
- 860201415 • 48" **\$59.99**



- ### T-STYLE DECK HOOK
- For trailers with a channel in the floor.
  - 860200995
  - \$17.99**



- ### SCREW STYLE DECK HOOK
- Most common.
  - Comes standard with all Superclamps.
  - Screws into the existing hole where you would screw the old style bar and crank into.
  - 860200994
  - \$17.99**



- ### SUPERTRAC DECK HOOK
- 860201416
  - \$19.99**

### SUPERCLAMP

- Secure your sled with a simple pull of the handle.
- Durable composite construction.
- According to certain state or provincial laws, the use of both Superclamps may be required.

**DID YOU KNOW**  
Superclamps are the fastest way to secure your sled to your deck.



### SUPERCLAMP II

- Innovative trailer tie-down system.
- Silicone rubber pads to protect your skis.
- Front and middle handles allowing easy manoeuvrability.
- Pad lock compatible, becomes a theft deterrent.
- Tension adjustment knob, fits all snowmobiles.
- 860200950
- \$209.99**

### SUPERCLAMP REAR WITH SUPERTRAC

- Snowmobile tie-down system for rail.
- Silicone rubber pads to protect snowmobile suspension skid.
- Tension adjustment knob - fits all snowmobiles.
- Screw style deck hook comes standard with all Superclamps.
- Pad lock compatible, becomes a theft deterrent.
- 860201425
- \$139.99**



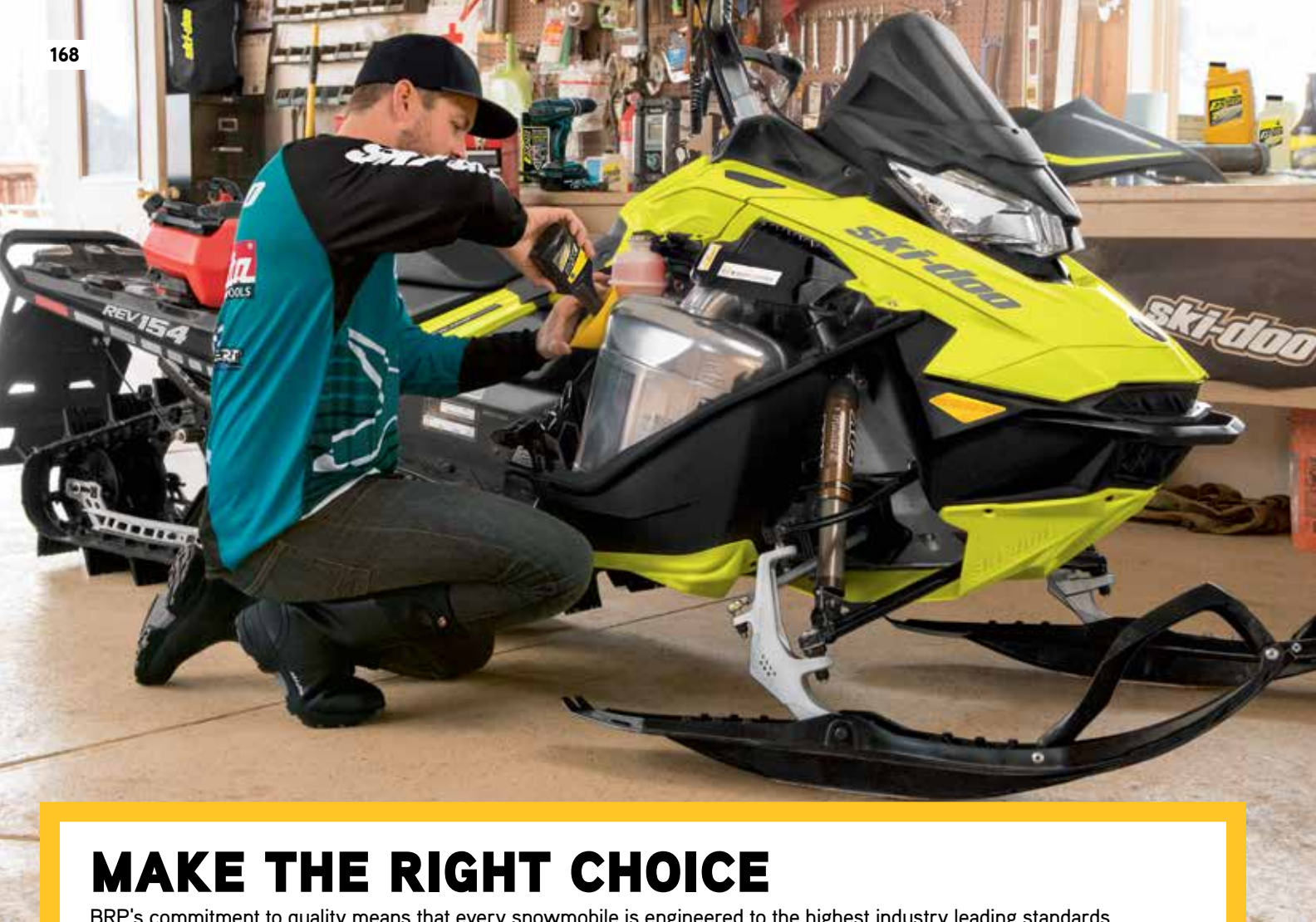

## MAKE THE RIGHT CHOICE

BRP's commitment to quality means that every snowmobile is engineered to the highest industry leading standards. Nevertheless, a lack of proper maintenance may cause even the best components to eventually fail.

**BY USING ORIGINAL BRP MAINTENANCE PARTS, YOU ARE TAKING CARE OF YOUR INVESTMENT.**

## 7 ESSENTIAL BRP PRODUCTS TO ENSURE A PROPER TUNE-UP



**DRIVE BELTS**  
P. 158



**BEARINGS**  
P. 160



**XPS 4-STROKE OIL CHANGE KITS**  
P. 171



**CLUTCH MAINTENANCE KITS**  
P. 157



**XPS SYNTHETIC CHAINCASE OIL**  
P. 172



**CARBIDES**  
P. 150



**TRACKS**  
P. 143



# MORE THAN JUST OIL

The XPS brand has a complete family of performance products to expertly protect, enhance, and extend the life of your BRP vehicle. Every XPS product has been tested and approved for complete peace of mind. No second guesses, no assumptions. The exact product to use, every time.



**AFTER ALL, YOU ONLY GET OUT WHAT YOU PUT IN... SO IF YOU'RE CHOOSING ANYTHING OTHER THAN XPS, THEN YOU'RE NOT GIVING YOUR SKI-DOO SNOWMOBILE THE ABSOLUTE BEST.**

CHOOSING THE BEST FOR THE HARSHTEST CONDITIONS

# THE ULTIMATE PROVING GROUNDS

The challenges facing racers competing in the ultra long-distance races, Iron Dog and Cain's Quest, are very different from the snocross and cross-country races we are all familiar with. The races are long – 2,031 miles (3,200 km) for the Iron Dog in Alaska and about 2,174 miles (3,500 km). for Cain's Quest in Newfoundland. They are multi-day affairs and your route is basically up to you. Some of the race is on established trails, but you're also riding over ocean ice, fjords, bogs, forest and even evil suspension-eating humps called tussocks. Two-man teams are required for safety reasons.

To compete – just finish, even – your sled needs to be incredibly tough and capable, plus be able to carry extra fuel, gear and survival items. You might think that competitors custom fabricate their sleds and gear, like desert-racing trophy trucks. Sure, there are some custom alterations, but more race teams are just lightly modifying their Ski-Doo sleds and equipping them with the same accessories you can buy at your dealer.

"In the past we have had to spend a lot of time and money creating or finding the right items to successfully compete in this race," said Paul Sindorf, a veteran of eight Iron Dogs. "BRP now offers many of these items, so the work and engineering is already done. Now it is almost plug-and-play, so the time we usually would spend fabricating, sourcing and installing we can spend practicing and testing."

**We asked two privateer teams to share with us the BRP accessories they use on their race sleds.**

## ACADEMY MORTGAGE TEAM #23 IRON DOG

### 2016 RACERS

Paul Sindorf, Hatcher's Pass, Alaska  
Kristofer Sindorf, Palmer, Alaska

### 2016 RACE SLEDS

Renegade X 600 H.O. E-TEC

- |   |   |  |
|---|---|--|
| <ul style="list-style-type: none"> <li>• 16" (41 cm) Sport Performance Flared Windshield</li> <li>• LED Accessory Light</li> <li>• Montana GPS + Glovebox Extension + Mount Kit</li> <li>• Tank Bag</li> <li>• LinQ Tunnel Bag (Large)</li> <li>• LinQ Tunnel Bag (Medium)</li> <li>• Heavy-Duty Rear Bumper</li> </ul> | <ul style="list-style-type: none"> <li>• XC Front Bumper</li> <li>• Extreme Skid Plate</li> <li>• BRP clutching and gearing</li> <li>• KYB PRO-40 Race Shocks</li> <li>• XPS Oil</li> <li>• Extra Belts</li> <li>• Handlebar Riser</li> </ul> | <ul style="list-style-type: none"> <li>• 4th Axle Wheel Kit and Auxiliary Idler Wheels</li> <li>• Heavy-Duty Springs</li> <li>• 6" (15 cm) Extreme Carbides (2 carbides per ski)</li> <li>• Woody's Phantom Sharp Studs</li> <li>• Tunnel Protectors</li> <li>• Customized Wraps from SCS Unlimited</li> </ul> |
|---|---|--|



### MONTANA GPS

"One of the best integrated items is the extended glovebox with the powered GPS mount and Montana GPS from BRP," said Paul Sindorf of Academy Mortgage Team #23. "The ability to have the GPS screen easily readable right from the seat is mandatory. It was a lifesaver when we encountered severe blizzard conditions on the way back down the coast in 2015 [Iron Dog]. Visibility deteriorated to near zero and we had to navigate across the ice pack using only the Montana GPS. Had we gone the wrong direction, we could have headed out to sea."

## TEAM MAINE CAIN'S QUEST FOR MANY YEARS, IRON DOG 2014

### 2016 RACERS

Andrew Milley, Labrador City, Newfoundland.  
Robert Gardner, Mercer, Maine

### 2016 RACE SLEDS

Renegade X-RS 600 H.O. E-TEC

- |  |   |   |
|--|---|---|
| <ul style="list-style-type: none"> <li>• Extreme Skid Plate</li> <li>• LED Auxiliary Light</li> <li>• LinQ Fuel Caddy</li> <li>• Glovebox Extension and Liner</li> <li>• Handlebar Bag</li> <li>• Summit Seat Bag</li> </ul> | <ul style="list-style-type: none"> <li>• Ski-Doo Saddlebags</li> <li>• High Windshield</li> <li>• XPS Oil</li> <li>• BRP Belts</li> <li>• QRS Brace and Floating Secondary Kit</li> </ul> | <ul style="list-style-type: none"> <li>• Heated Visor Kit</li> <li>• Handlebar Muffs</li> <li>• Prefilter Vent Kit</li> <li>• Google Caddy</li> <li>• Ski-Doo Shovel</li> </ul> |
|--|---|---|

### LinQ TUNNEL BAGS

"Year after year we searched for the best way to attach our survival gear to the back of our race sleds," said Paul Sindorf of Academy Mortgage Team #23. "After the LinQ system was created, our problems were solved. We have been using the LinQ tunnel bags since 2009 and have never had any problems with them coming off or falling apart. We trust them to carry all of our mandatory survival gear."



**DID YOU KNOW** XPS oils are developed specifically for Rotax engines.

### XPS 2-STROKE FULL SYNTHETIC OIL

- Uniquely engineered for specialized lubrication and wear protection for E-TEC applications where less oil is used, and also formulated for low-smoke, low-odor performance.
- BRP-engineer-certified for use in Ski-Doo snowmobiles equipped with E-TEC engines.
- Extra detergency for optimum engine cleanliness, plus proprietary anti-wear additives for longer engine life.

293600132 • 1 quart / 946 ml  
293600133 • 1 US gallon / 3.785 L



**PERFECT MATCH WITH 850 E-TEC!**

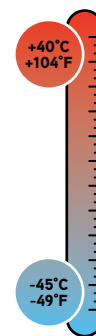

### XPS 4-STROKE SYNTHETIC OIL

- Specifically formulated and BRP engineer-certified for use in Ski-Doo snowmobiles equipped with Rotax 4-stroke engines.
- Premium synthetic base with custom additives package provides unmatched lubrication and enhanced corrosion protection.
- Provides easier starting in cold temperature and enhanced cold start protection.
- Cold weather pour point/flow temperature = -49°F/-45°C

293600112 • 1 quart / 946 ml  
293600115 • 1 US gallon / 3.785 L



### XPS 2-STROKE MINERAL OIL

- BRP engineer-certified to provide optimal lubrication at all running temperatures for carbureted, oil injected engines.
- Superior, high-detergency formula.
- Flows at -40°F/-40°C and also usable as a pre-mix.

293600117 • 1 quart / 946 ml  
293600118 • 1 US gallon / 3.785 L

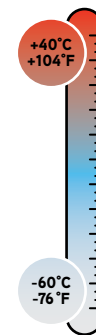

### XPS 4-STROKE SYNTHETIC OIL EXTREME COLD GRADE

- Engineered from premium high-quality base stocks and esters for superior cold weather oil flow in harsh winter climates.
- Provides quick and easy engine starting and superior cold weather protection at temperatures below -40°F/-40°C.
- Cold weather pour point/flow temperature = -76°F/-60°C

293600154 • 1 quart / 946 ml  
293600155 • 1 US gallon / 3.785 L



### XPS 4-STROKE OIL CHANGE KIT

- Ultra-convenient "all-in-one" oil change kit saves time and money.
- Includes XPS Synthetic Oil, oil filter, o-rings and washer.

415129979 • 1200 4-TEC  
415129725 • 600 ACE  
415129866 • 900 ACE



### XPS PREMIX OIL

- Superior performance 2-stroke oil developed especially for Rotax 2-stroke engines.
- Formulated for fast and easy mixing at very cold temperatures.

293600120 • 500 ml



Note: Please contact your nearest dealer for suggested retail prices of oil based products.

### XPS CARBON FREE FUEL TREATMENT

- Prevents problems inherent in Ethanol-blended fuels.
- Extends storage life of fuel up to 12 months.
- Cleans fuel system while preventing corrosion and oxidation.
- Helps keep piston rings, valves and combustion chamber carbon-free to prevent difficult starting and restore peak performance.

219702533 • 355 ml  
**\$8.99**



### XPS FUEL STABILIZER

- Extends fuel life by preventing fuel breakdown during storage.
- Helps prevent difficult starting, throttle hesitation and poor performance.
- Anti-corrosive, anti-oxidant formula protects fuel system and engine.
- Prevents problems inherent in Ethanol-blended fuels.

413408601 • 8 oz.  
**\$9.99**



### XPS PRE-MIXED ANTIFREEZE/COOLANT

- Pre-mixed, ready-to-use.
- Exceptional 5-year extended service life.
- Provides superior heat transfer, protection against corrosion and cavitation.
- Specifically formulated for use in your Ski-Doo snowmobile.
- Ideal as a replacement coolant in vehicles that usually use 2-year antifreeze/coolant (green).

219702685  
5 years (orange) - 1 quart / 946 ml  
**\$9.99**



▶ Watch 2-stroke & 4-stroke oil videos. [www.xpslubricants.com](http://www.xpslubricants.com)

**XPS STORAGE OIL**

- This specialty oil is a must when putting your Ski-Doo snowmobile away in the spring.
- Specially formulated to protect the engine's internal parts from the hazards of rust and corrosion due to condensation during storage or prolonged periods of non-use.

413711900 • 350 g  
**\$9.99**



**XPS LUBE**

- A multipurpose lubricant that prevents rust, corrosion and moisture intrusion.
- Contains active extreme-pressure additives that provide excellent lubrication and anti-wear properties.
- Comes in a spray can that works upside down.

293600016 • 14 oz.  
**\$11.99**



**XPS DOT 4 BRAKE FLUID**

- Exceeds DOT 3 and 4 requirements.
- Low-moisture formulation providing maximum protection against vapor lock.
- Recommended in Ski-Doo snowmobiles.

293600131  
**\$9.99**

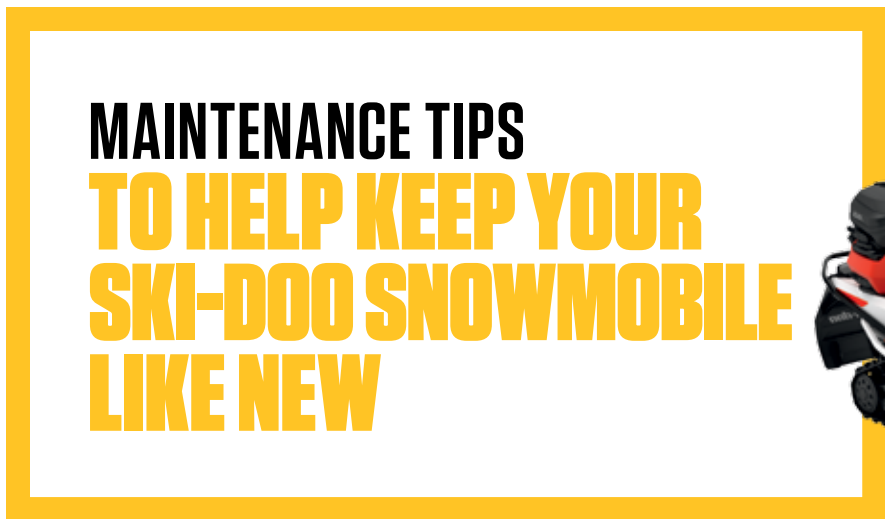

**XPS HPG SHOCK OIL**

- High-quality shock oil for performance shocks used in severe conditions.
- Impedes foaming to reduce fade.

293600035 • 1 L  
**\$73.99**



**XPS MINERAL CHAINCASE OIL**

- Dependable mineral-based chaincase protection.

415129500 • 250 ml  
**\$7.99**



**XPS SYNTHETIC CHAINCASE OIL**

- The best in multigrade chain lubrication, specifically developed for our high performance models.
- Offers wide operating range of temperatures.

293600138 • 355 ml  
**\$11.99**



**MAINTENANCE TIPS**

**1**

**TRACK AND REAR SUSPENSION**

Visually inspect all suspension components including slider shoes, wheels and bearings. Lubricate any grease fittings using XPS Suspension Grease. While checking the rear suspension, inspect the track for damage or excessive wear. Check your studs to ensure they're tight and they're not excessively worn. Check the tension and alignment, and adjust as needed.

Studs **P. 142**  
 Tracks **P. 143**  
 Slider Shoes **P. 145**  
 Bearings **P. 160**



**2**

**DRIVE SYSTEM**

Clean the drive and driven pulley flange surface using BRP Pulley Flange cleaner that leaves no residue that can cause belt slippage. Inspect belt for cracks, fraying or abnormal wear. Replace if needed.

**Drive Belt Height Adjustment:** In order to ensure the best performance, the drive belt height must be checked every time a new drive belt is installed or as the belt wears.

Drive Belts **P. 158**  
 XPS Pulley Flange Cleaner **P. 172**



**3**

**FLUID LEVELS**

Check engine or injection oil, brake fluids and coolant levels. Adjust or top off when necessary. Change chaincase or transmission oil annually during preseason preparation.

XPS 4-stroke Synthetic Oil, **P. 171**  
 XPS 2-stroke Synthetic Oil **P. 171**  
 XPS DOT 4 Brake Fluid **P. 172**  
 XPS Pre-Mixed Antifreeze/Coolant **P. 171**  
 XPS Chaincase Oil **P. 172**



**4**

**FUEL SYSTEM**

Control the inherent moisture problems today's ethanol-blended fuels can cause by periodically adding fuel treatments. XPS Fuel Stabilizer will protect against corrosion, stabilize the fuel to fight oxidation and fuel system deposits. XPS Carbon Free adds fuel system and engine intake cleaning.

XPS Carbon Free Fuel Treatment **P. 171**  
 XPS Fuel Stabilizer **P. 171**



**5**

**CLEANING**

Post ride care and cleaning: Remove snow and ice from rear suspension, track, front suspension, steering mechanism and skis. Cover your snowmobile when leaving it outside overnight or during extended periods of inactivity. Wash your vehicle with a microfiber cloth and surface compatible cleaner.

XPS Microfiber Towel **P. 172**  
 XPS Spray Cleaner and Polish **P. 172**



**XPS SUSPENSION GREASE**

- Provides optimal lubrication at extremes temperature.
- Protects against external contamination.
- Specifically formulated for use in Ski-Doo snowmobiles.
- Allows suspensions to perform regardless of conditions.

293550033 • 400 g  
**\$8.99**



**XPS PULLEY FLANGE CLEANER**

- Easy-to-use cleaner specifically developed to quickly remove gunk and grime from primary and secondary pulley flanges.
- No rinsing required.

413711809 • 320 g  
**\$20.99**



**XPS HEAVY-DUTY CLEANER**

- Strong citrus-based engine cleaner for jobs such as removing grease, oil and grime.

**Not available in the US.**  
 293110001 • 400 g  
**\$13.99**



**XPS BRAKES & PARTS CLEANER**

- A concentrated blend of solvents with a powerful blasting spray that effectively removes grease, grime, brake fluid and other contaminants from brake components and metal parts.
- Evaporates instantly and completely, leaving no residue to hinder performance.
- Contains no ozone depleters.

219701705 • 14 oz. / 397 g  
**\$7.99**



**XPS SPRAY CLEANER & POLISH**

- Removes dirt, grease, and water marks easily and quickly.
- Non-petroleum-based formula will not harm plastic finishes.

219702844 • 340 g  
**\$9.99**



**XPS MICROFIBER TOWELS**

- Made of extremely fine fibers, their soft surfaces have been perfected for polishing painted, gelcoated and hard shiny surfaces.
- They are so absorbent they hold up to 7 times their weight in water.
- Machine washable means they can be used over and over again.

219701759 • Pack of 2  
**\$8.99**



**EXTENDED STORAGE TIPS\***

**DID YOU KNOW**  
 Planning to store your Ski-Doo snowmobile for 3 months or more? Here are a few things you can do to ensure it comes out of storage running as smoothly as the day you put it in.

- After cleaning and drying your snowmobile, use XPS Lube on all metallic parts to minimize corrosion.
- Use a Yuasa Charger to keep your battery completely charged over months of non-use.
- Top-off the gas tank, and add XPS Carbon Free Fuel Treatment or XPS Fuel Stabilizer.
- Lubricate the engine's internal parts using XPS Storage Oil. On E-Tec engines, activate the Engine Storage Mode.

\*Note: Please refer to your operator's guide for complete storage procedure.

CONSULT YOUR AUTHORIZED SKI-DOO SNOWMOBILE DEALER: YOUR PARTNER FOR VEHICLE MAINTENANCE EXCELLENCE.



# USING THE RIGHT OIL MATTERS

The right oil delivers:

**THE BEST PERFORMANCE**  
**THE BEST RELIABILITY**  
**THE LONGEST LIFE**

It's a balancing act to deliver all three attributes – and only XPS, with its custom blend formulations and carefully matched additives, is specifically designed to do just that in a Rotax engine.



**“The best oil is the oil that was specifically designed for the engine, without compromising the engine.”**

Mischa Zimmermann  
 Project Leader Engine Development, BRP

Find out why oil matters at [www.xpslubricants.com](http://www.xpslubricants.com)



## DOES ONE OIL FIT ALL?

Our efficient, high-output engines place strong demands on engine oil. At BRP, we treat oil like an actual mechanical part that needs to be developed alongside the engine it is intended for, throughout its entire design, testing and validation process. XPS is the best choice for our Rotax engines because the oil is engineered at the same time as our existing and emerging new engine technology. Each engine type has its own specific needs and characteristics that the oil must match. Not all oil manufacturers do.

### 2-STROKE OIL

**Fact:** XPS synthetic 2-stroke oil is subjected to extensive research and validation to allow the unique properties of E-TEC technology to reach their full potential. It's the kind of chemistry you won't find in any other oil.

### 4-STROKE OIL

**Fact:** XPS 4-stroke oil is BRP engineer-certified for unmatched lubrication, quick and easy cold starting, and oil flow in harsh winter conditions and extreme cold temperatures that delivers cold start protection against engine wear.

## WHY NOT CHOOSE A LOW-COST ALTERNATIVE INSTEAD OF XPS ENGINE OILS?

BRP engineers and experts like Mischa Zimmermann have proven repeatedly that other brands of oil behave differently in Rotax engines.

- Each vehicle manufacturer establishes their own internal matching and compatibility standards and criterias for their OEM oil manufacturer.
- Aftermarket oil suppliers mostly follow existing industry standards for compliance purposes, but this is a common practice for general applications, and nowhere near the synergetic and concurrent engine-engine oil design and validation procedure we adhere to.
- Even oil that is more expensive than XPS will not have the same custom-matched results.
- Only XPS is designed exclusively in synch with Rotax engine technology, including its high-demand E-TEC direct fuel injection.
- Our oil is tested on the whole line-up of vehicles we manufacture and their engines – not just one or two models – and despite what other oil suppliers claim, we actually validate and revalidate the life span of both the engine and vehicle, meaning we put in thousands of dynamometer hours and hundreds of thousands of miles of hard real world test riding, as opposed to relying only on the equivalent of one season of usage other oil suppliers advertise.

## AREN'T THERE OTHER HIGH QUALITY OILS ON THE MARKET?

Yes. But no other oil is designed as an actual mechanical part during engine development like XPS. The best oil is the oil engineered with carefully matched additives matrixed to meet exactly what the engine needs. Your satisfaction matters. We want you to have the best experience with your BRP vehicle, so we set extremely high standards for XPS oil.

# YOU BOUGHT THE BEST VEHICLE AVAILABLE ON THE MARKET. IT DESERVES THE BEST MAINTENANCE PRODUCTS IN THE WORLD.

Going to your BRP dealership for regular maintenance servicing can prevent bigger and more expensive repairs in the long run. Just follow the recommended maintenance schedule. It was designed by experts who understand your Ski-Doo and know how to keep it in top form. Take care of your vehicle by maintaining it using strictly BRP and Rotax OEM or 100% Ski-Doo approved parts and products.

## RECOMMENDED PERIODIC MAINTENANCE SCHEDULE FOR E-TEC, ACE & 1200 4-TEC POWERED VEHICLES

SYSTEM	COMPONENT	ACTION	First Inspection 300 mi. (500 km)	Every 1,000 mi. (1,500 km)	Every 2,000 mi. (3,000 km) or 1 year	Every 4,000 mi. (6,000 km) or 2 years	Every 6,000 mi. (10,000 km) or 3 years	Every 5 years
ENGINE	Oil System 4-Stroke	Replace oil and oil filter			After the first 2,000 mi. (3,000 km) ACE and 1200 4-TEC	or once a year		
	Seals and Gaskets (ACE and 1200 4-TEC)	Inspect						
	Spark Plugs	Replace						
	Rewind Starter	Clean and lubricate						
	3D-RAVE Valves (E-TEC)	Clean						
FUEL	In Line Fuel Filter (E-TEC)	Replace						
	Fuel Lines & Connections	Inspect						
	Fuel Pump Strainer (E-TEC)	Inspect or replace						
OIL SYSTEM (E-TEC)	Fuel Pump Outlet Filter (ACE and 1200 4-TEC)	Replace						
	Pump Strainer	Inspect/clean						
COOLING	Coolant	Check level						
		Replace						
EXHAUST	System	Inspect and check for leaks						
REAR SUSPENSION	Idler Wheels	Check bearings, inspect rubber						
	Slider Shoes & Stopper Straps, Bolts	Inspect						
	Axles & Pivots	Grease/lubricate						
TRACK	Track	Adjust and align						
FRONT SUSPENSION	Shocks, Springs, A-Arms, Bolts	Inspect						
SKIS	Skis & Runners	Inspect skis and runners						
	Drive Pulley	Visually inspect/clean						
		Tighten retainer screw						
	Slider Shoes, O-Rings, Sliding Sheave Bushing (E-TEC)	Replace						
	Spring Cover Bushing & Ramps (E-TEC)	Replace						
PULLEY SYSTEM	Drive Belt	Inspect						
		Inspect						
	Driven Pulley	Check preload (ACE)						
		Clean						
DRIVE SYSTEM	Drive Chain	Adjust						
	Chaincase Oil	Change						
BRAKING SYSTEM		Check oil level						
	Brake Fluid	Check level						
		Replace						
BODY	Brake Pads, Hose & Disc	Inspect						
	Engine Rubber Mounts	Inspect						
CONTROLS	Engine Stopper (E-TEC)	Adjust						
	Throttle Cable (E-TEC)	Inspect						
	Steering Mechanism	Inspect						

# WIN YOUR DREAM ACCESSORIZED SKI-DOO SLED

**YOU COULD GET THE ULTIMATE GIFT – THE 2017 SKI-DOO SNOWMOBILE OF YOUR CHOICE.**

Just enter our drawing for a chance to win the accessorized Ski-Doo snowmobile of your choice.



**ENTER NOW [WWW.SKI-DOO.COM/WIN-SKIDOO-CONTEST](http://WWW.SKI-DOO.COM/WIN-SKIDOO-CONTEST)**

# RIDE IT HARD. TREAT IT RIGHT.



## XPS. THE ONLY OIL ENGINEERED BY BRP FOR THE LEVEL OF PERFORMANCE YOU EXPECT.

FOR THE FULL XPS STORY, VISIT [WWW.XPSLUBRICANTS.COM](http://WWW.XPSLUBRICANTS.COM)

©2016 Bombardier Recreational Products Inc., (BRP). All rights reserved. ® and the BRP logo are trademarks of BRP or its affiliates. Depending on location, products are distributed by BRP US Inc. or Bombardier Recreational Products Inc. \* No purchase necessary to enter or win. This Sweepstakes is open to legal residents of Canada and the United States (excluding Puerto Rico) who have reached the age of majority in their states/provinces of residence as of the date the Sweepstakes begins and have a valid email address. Maximum retail value of prize up to \$20,000 USD/ \$24,000 CAD. Subject to Sweepstakes Official Rules available at: [http://www.ski-doo.com/Files/en-US/Pdf/win\\_o\\_brp\\_contest.pdf](http://www.ski-doo.com/Files/en-US/Pdf/win_o_brp_contest.pdf). Please ride responsibly and safely and wear appropriate protective clothing. Remember that riding and alcohol/drugs don't mix.